

Description

CNR D/V/P/H/N series metal oxide varistor are nonlinear resistors, consisting main of zinc oxide and several kinds of metal oxide additive. They are bilateral and symmetrical V-I characteristics curve and unparalleled large peak current capability are used for absorption of transient voltage, suppression of pulse noise and circuit voltage stabilization.

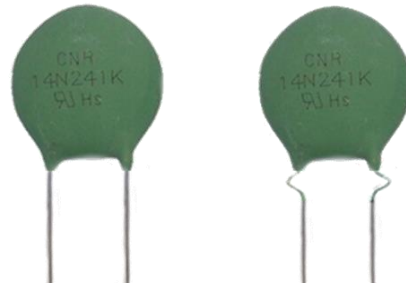

Agency Approvals		
Agency	Agency Approval	Certificate No.
	UL 1449 4 th & cUL	VZCA2.E316325 VZCA8.E316325
	IEC 61051-1:2007-04	40044872
	IEC 61051-2:2009-05	
	IEC 61051-2-2:1991-01	
	IEC 60950-1:2013 for 10mm,14mm,18mm and 20mm only	
	GB/T 10193-1997	CQC16001152600
	GB/T 10194-1997	CQC16001152601
	GB 4943.1-2011	CQC16001152602
	GB 8898-2011	CQC16001152603 CQC16001152604 CQC16001152605

Features
1. RoHS compliant
2. Halogen-free Series are available
3. Body size: $\varnothing 5 \sim \varnothing 20\text{mm}$
4. CNR-10N201K~10N751K ,CNR-14N201K~14N751K, CNR-20N201K~20N751K ,CNR-20N201K~20N751K meet IEC 60950-1:2013 Annex Q requirement.
Applications
1. Power supply
2. Home appliance
3. Industrial equipment
4. Lighting products
5. Photovoltaic industry

Max. Rating		
	N-Seires	Units
AC Voltage Range (Vac)	11 to 460	V
DC Voltage Range(Vdc)	14 to 615	V
Peak Current for 8/20 μ S Current Wave	350 to 20000	A
Energy Range For 10/1000 μ S Current Wave	0.9 to 725	J
Operation Ambient Temperature Range	-40 to +125	$^{\circ}\text{C}$
Storage Tempersture Range	-40 to +150	$^{\circ}\text{C}$
Varistor Voltage Range Vn(Vdc)	18 to 750	V
Insulation Resistance	>1000	M Ω
Typical Response Time	<25	ns



Device Ratings and Characteristics														
Part No.	Device Marking	Maximum Allowable Voltage		Varistor Voltage (@1mA)			Clamping Voltage @ Test Current (@8/20µs)		Maximum Energy (@10/1000µs)	Maximum Peak Current (@8/20µs)	Rated Power (W)	Typical Capacitance (@1KHz) (pF)	UL 1449 4th, In @8/20us (KA)	Related Standards Symbol
		ACrms(V)	DC(V)	Vn(Vdc)	Min.	Max.	Vc(V)	Ip(A)	(J)	(A)				
CNR-05N180K	05N180K	11	14	18	16	20	36	1	0.9	350	0.02	1480	0.15	⊙
CNR-05N220K	05N220K	14	18	22	20	24	43	1	1.1	350	0.02	1320		⊙
CNR-05N270K	05N270K	17	22	27	24	30	53	1	1.4	350	0.02	1030		⊙
CNR-05N330K	05N330K	20	26	33	30	36	65	1	1.7	350	0.02	760		⊙
CNR-05N390K	05N390K	25	31	39	35	43	77	1	2.1	350	0.02	720		⊙
CNR-05N470K	05N470K	30	38	47	42	52	93	1	2.5	350	0.02	620		⊙
CNR-05N560K	05N560K	35	45	56	50	62	110	1	3.1	350	0.02	515		⊙
CNR-05N680K	05N680K	40	56	68	61	75	135	1	3.6	350	0.02	450		⊙
CNR-05N201K	05N201K	130	170	200	180	220	340	10	13	1200	0.05	100	0.25	□
CNR-05N221K	05N221K	140	180	220	198	242	360	10	14	1200	0.25	100		□
CNR-05N241K	05N241K	150	200	240	216	264	395	10	15	1200	0.25	95		□
CNR-05N271K	05N271K	175	225	270	243	297	455	10	18	1200	0.25	95		□
CNR-05N301K	05N301K	195	250	300	270	330	500	10	19	1200	0.25	90		□
CNR-05N331K	05N331K	215	275	330	297	363	550	10	21	1200	0.25	90		□
CNR-05N361K	05N361K	230	300	360	324	396	595	10	23	1200	0.25	85		□
CNR-05N391K	05N391K	250	320	390	351	429	650	10	25	1200	0.25	80		□
CNR-05N431K	05N431K	275	350	430	387	473	710	10	28	1200	0.25	75		□
CNR-05N471K	05N471K	300	385	470	423	517	775	10	30	1200	0.25	70		□
CNR-05N511K	05N511K	320	420	510	459	561	845	10	30	1200	0.25	65		□
CNR-05N561K	05N561K	350	460	560	504	616	915	10	30	1200	0.25	60		□
CNR-05N621K	05N621K	395	510	620	558	682	1020	10	30	1200	0.25	55		□
CNR-05N681K	05N681K	420	560	680	612	748	1120	10	30	1200	0.25	50		□
CNR-05N751K	05N751K	465	615	750	675	825	1235	10	33	1200	0.25	40		□

Related Standards

Symbols	□	⊙
Approval		

Note : VDE & CQC Certification are under appoaling



Device Ratings and Characteristics														
Part No.	Device Marking	Maximum Allowable Voltage		Varistor Voltage (@1mA)			Clamping Voltage @ Test Current (@8/20µs)		Maximum Energy (@10/1000µs)	Maximum Peak Current (@8/20µs)	Rated Power (W)	Typical Capacitance (@1KHz)	UL 1449 4th, In @8/20us	Related Standards Symbol
		ACrms(V)	DC(V)	Vn(Vdc)	Min.	Max.	Vc(V)	Ip(A)	(J)	(A)		(pF)	(KA)	
CNR-07N180K	07N180K	11	14	18	16	20	36	2.5	2.1	750	0.05	3600	0.5	⊙
CNR-07N220K	07N220K	14	18	22	20	24	43	2.5	2.5	750	0.05	3200		⊙
CNR-07N270K	07N270K	17	22	27	24	30	53	2.5	3	750	0.05	2500		⊙
CNR-07N330K	07N330K	20	26	33	30	36	65	2.5	4	750	0.05	1850		⊙
CNR-07N390K	07N390K	25	31	39	35	43	77	2.5	4.6	750	0.05	1750		⊙
CNR-07N470K	07N470K	30	38	47	42	52	93	2.5	5.5	750	0.05	1500		⊙
CNR-07N560K	07N560K	35	45	56	50	62	110	2.5	7	750	0.05	1250		⊙
CNR-07N680K	07N680K	40	56	68	61	75	135	2.5	8.2	750	0.05	1100		⊙
CNR-07N201K	07N201K	130	170	200	180	220	340	25	26	2500	0.3	220	0.5	□
CNR-07N221K	07N221K	140	180	220	198	242	360	25	30	2500	0.3	210		□
CNR-07N241K	07N241K	150	200	240	216	264	395	25	33	2500	0.3	190		□
CNR-07N271K	07N271K	175	225	270	243	297	455	25	39	2500	0.3	165		□
CNR-07N301K	07N301K	195	250	300	270	330	500	25	42	2500	0.3	155		□
CNR-07N331K	07N331K	215	275	330	297	363	550	25	44	2500	0.3	145		□
CNR-07N361K	07N361K	230	300	360	324	396	595	25	50	2500	0.3	145		□
CNR-07N391K	07N391K	250	320	390	351	429	650	25	53	2500	0.3	145		□
CNR-07N431K	07N431K	275	350	430	387	473	710	25	60	2500	0.3	130		□
CNR-07N471K	07N471K	300	385	470	423	517	775	25	65	2500	0.3	110		□
CNR-07N511K	07N511K	320	420	510	459	561	845	25	70	2500	0.3	100		□
CNR-07N561K	07N561K	350	460	560	504	616	915	25	75	2500	0.3	100		□
CNR-07N621K	07N621K	395	510	620	558	682	1020	25	80	2500	0.3	100		□
CNR-07N681K	07N681K	420	560	680	612	748	1120	25	85	2500	0.3	90		□
CNR-07N751K	07N751K	465	615	750	675	825	1235	25	92	2500	0.3	90		□

Related Standards

Symbols	□			⊙		
Approval						

Note : VDE & CQC Certification are under appovaling



Device Ratings and Characteristics														
Part No.	Device Marking	Maximum Allowable Voltage		Varistor Voltage (@1mA)			Clamping Voltage @ Test Current (@8/20µs)		Maximum Energy (@10/1000µs)	Maximum Peak Current (@8/20µs)	Rated Power (W)	Typical Capacitance (@1KHz) (pF)	UL 1449 4th, In @8/20us (KA)	Related Standards Symbol
		ACrms(V)	DC(V)	Vn(Vdc)	Min.	Max.	Vc(V)	Ip(A)	(J)	(A)				
CNR-10N180K	10N180K	11	14	18	16	20	36	5	4	1500	0.08	8000	1	⊙
CNR-10N220K	10N220K	14	18	22	20	24	43	5	5	1500	0.08	7000		⊙
CNR-10N270K	10N270K	17	22	27	24	30	53	5	6	1500	0.08	5500		⊙
CNR-10N330K	10N330K	20	26	33	30	36	65	5	7.5	1500	0.08	4100		⊙
CNR-10N390K	10N390K	25	31	39	35	43	77	5	8.6	1500	0.08	3900		⊙
CNR-10N470K	10N470K	30	38	47	42	52	93	5	10	1500	0.08	3300		⊙
CNR-10N560K	10N560K	35	45	56	50	62	110	5	11	1500	0.08	2800		⊙
CNR-10N680K	10N680K	40	56	68	61	75	135	5	14	1500	0.08	2300		⊙
CNR-10N201K	10N201K	130	170	200	180	220	340	50	52	4500	0.5	420	2	□
CNR-10N221K	10N221K	140	180	220	198	242	360	50	58	4500	0.5	390		□
CNR-10N241K	10N241K	150	200	240	216	264	395	50	64	4500	0.5	360		□
CNR-10N271K	10N271K	175	225	270	243	297	455	50	67	4500	0.5	330		□
CNR-10N301K	10N301K	195	250	300	270	330	500	50	70	4500	0.5	300		□
CNR-10N331K	10N331K	215	275	330	297	363	550	50	78	4500	0.5	270		□
CNR-10N361K	10N361K	230	300	360	324	396	595	50	84	4500	0.5	250		□
CNR-10N391K	10N391K	250	320	390	351	429	650	50	91	4500	0.5	230		□
CNR-10N431K	10N431K	275	350	430	387	473	710	50	99	4500	0.5	220		□
CNR-10N471K	10N471K	300	385	470	423	517	775	50	107	4500	0.5	200		□
CNR-10N511K	10N511K	320	420	510	459	561	845	50	117	4500	0.5	190		□
CNR-10N561K	10N561K	350	460	560	504	616	915	50	125	4500	0.5	180		□
CNR-10N621K	10N621K	395	510	620	558	682	1020	50	128	4500	0.5	160		□
CNR-10N681K	10N681K	420	560	680	612	748	1120	50	134	4500	0.5	140		□
CNR-10N751K	10N751K	465	615	750	675	825	1235	50	146	4500	0.5	130		□

Related Standards

Symbols	□	⊙
Approval		

Note : VDE & CQC Certification are under appovaling



Device Ratings and Characteristics														
Part No.	Device Marking	Maximum Allowable Voltage		Varistor Voltage (@1mA)			Clamping Voltage @ Test Current (@8/20µs)		Maximum Energy (@10/1000µs)	Maximum Peak Current (@8/20µs)	Rated Power (W)	Typical Capacitance (@1KHz) (pF)	UL 1449 4th, In @8/20us (KA)	Related Standards Symbol
		ACrms(V)	DC(V)	Vn(Vdc)	Min.	Max.	Vc(V)	Ip(A)	(J)	(A)				
CNR-14N180K	14N180K	11	14	18	16	20	36	10	11	3000	0.15	18500	2	⊙
CNR-14N220K	14N220K	14	18	22	20	24	43	10	14	3000	0.15	16400		⊙
CNR-14N270K	14N270K	17	22	27	24	30	53	10	18	3000	0.15	13000		⊙
CNR-14N330K	14N330K	20	26	33	30	36	65	10	23	3000	0.15	9500		⊙
CNR-14N390K	14N390K	25	31	39	35	43	77	10	26	3000	0.15	8800		⊙
CNR-14N470K	14N470K	30	38	47	42	52	93	10	33	3000	0.15	7700		⊙
CNR-14N560K	14N560K	35	45	56	50	62	110	10	41	3000	0.15	6400		⊙
CNR-14N680K	14N680K	40	56	68	61	75	135	10	46	3000	0.15	5600		⊙
CNR-14N201K	14N201K	130	170	200	180	220	340	100	140	10000	1	860	3	□
CNR-14N221K	14N221K	140	180	220	198	242	360	100	155	10000	1	810		□
CNR-14N241K	14N241K	150	200	240	216	264	395	100	168	10000	1	860		□
CNR-14N271K	14N271K	175	225	270	243	297	455	100	190	10000	1	700		□
CNR-14N301K	14N301K	195	250	300	270	330	500	100	209	10000	1	640		□
CNR-14N331K	14N331K	215	275	330	297	363	550	100	228	10000	1	580		□
CNR-14N361K	14N361K	230	300	360	324	396	595	100	255	10000	1	530		□
CNR-14N391K	14N391K	250	320	390	351	429	650	100	275	10000	1	480		□
CNR-14N431K	14N431K	275	350	430	387	473	710	100	303	10000	1	430		□
CNR-14N471K	14N471K	300	385	470	423	517	775	100	350	10000	1	380		□
CNR-14N511K	14N511K	320	410	510	459	561	845	100	382	10000	1	350		□
CNR-14N561K	14N561K	350	460	560	504	616	915	100	382	10000	1	320		□
CNR-14N621K	14N621K	395	510	620	558	682	1020	100	382	7500	1	300		□
CNR-14N681K	14N681K	420	560	680	612	748	1120	100	382	7500	1	270		□
CNR-14N751K	14N751K	465	615	750	675	825	1235	100	420	7500	1	250		□

Related Standards

Symbols	□			⊙		
Approval						

Note : VDE & CQC Certification are under appoaling



Device Ratings and Characteristics														
Part No.	Device Marking	Maximum Allowable Voltage		Varistor Voltage (@1mA)			Clamping Voltage @ Test Current (@8/20µs)		Maximum Energy (@10/1000µs)	Maximum Peak Current (@8/20µs)	Rated Power (W)	Typical Capacitance (@1KHz) (pF)	UL 1449 4th, In @8/20us (KA)	Related Standards Symbol
		ACrms(V)	DC(V)	Vn(Vdc)	Min.	Max.	Vc(V)	Ip(A)	(J)	(A)				
CNR-18N180K	18N180K	11	14	18	16	20	36	15	22	4500	0.2	18500	3	⊙
CNR-18N220K	18N220K	14	18	22	20	24	43	15	28	4500	0.2	16400		⊙
CNR-18N270K	18N270K	17	22	27	24	30	53	15	36	4500	0.2	13000		⊙
CNR-18N330K	18N330K	20	26	33	30	36	65	15	46	4500	0.2	9500		⊙
CNR-18N390K	18N390K	25	31	39	35	43	77	15	52	4500	0.2	8800		⊙
CNR-18N470K	18N470K	30	38	47	42	52	93	15	66	4500	0.2	7700		⊙
CNR-18N560K	18N560K	35	45	56	50	62	110	15	82	4500	0.2	6400		⊙
CNR-18N680K	18N680K	40	56	68	61	75	135	15	92	4500	0.2	5600		⊙
CNR-18N201K	18N201K	130	170	200	180	220	340	125	252	15000	1	860	5	□
CNR-18N221K	18N221K	140	180	220	198	242	360	125	279	15000	1	810		□
CNR-18N241K	18N241K	150	200	240	216	264	395	125	302	15000	1	860		□
CNR-18N271K	18N271K	175	225	270	243	297	455	125	342	15000	1	700		□
CNR-18N301K	18N301K	195	250	300	270	330	500	125	376	15000	1	640		□
CNR-18N331K	18N331K	210	275	330	297	363	550	125	410	15000	1	580		□
CNR-18N361K	18N361K	230	300	360	324	396	595	125	405	15000	1	530		□
CNR-18N391K	18N391K	250	320	390	351	429	650	125	495	15000	1	480		□
CNR-18N431K	18N431K	275	350	430	387	473	710	125	545	15000	1	430		□
CNR-18N471K	18N471K	300	385	470	423	517	775	125	630	15000	1	380		□
CNR-18N511K	18N511K	320	418	510	459	561	845	125	687	15000	1	350		□
CNR-18N561K	18N561K	350	460	560	504	616	915	125	687	15000	1	320		□
CNR-18N621K	18N621K	385	505	620	558	682	1020	125	687	12000	1	300		□
CNR-18N681K	18N681K	420	560	680	612	748	1120	125	687	12000	1	270		□
CNR-18N751K	18N751K	460	615	750	675	825	1235	125	756	12000	1	240		□

Related Standards

Symbols	□			⊙		
Approval						

Note : VDE & CQC Certification are under appoaling



Device Ratings and Characteristics														
Part No.	Device Marking	Maximum Allowable Voltage		Varistor Voltage (@1mA)			Clamping Voltage @ Test Current (@8/20µs)		Maximum Energy (@10/1000µs)	Maximum Peak Current (@8/20µs)	Rated Power	Typical Capacitance (@1KHz)	UL 1449 4th, In @8/20us	Related Standards Symbol
		ACrms(V)	DC(V)	Vn(Vdc)	Min.	Max.	Vc(V)	Ip(A)	(J)	(A)	(W)	(pF)	(KA)	
CNR-20N180K	20N180K	11	14	18	16	20	36	20	28	6000	0.3	42000	3	⊙
CNR-20N220K	20N220K	14	18	22	20	24	43	20	36	6000	0.3	37000		⊙
CNR-20N270K	20N270K	17	22	27	24	30	53	20	46	6000	0.3	29200		⊙
CNR-20N330K	20N330K	20	26	33	30	36	65	20	59	6000	0.3	21400		⊙
CNR-20N390K	20N390K	25	31	39	35	43	77	20	67	6000	0.3	19800		⊙
CNR-20N470K	20N470K	30	38	47	42	52	93	20	85	6000	0.3	17300		⊙
CNR-20N560K	20N560K	35	45	56	50	62	110	20	106	6000	0.3	14400		⊙
CNR-20N680K	20N680K	40	56	68	61	75	135	20	119	6000	0.3	12600		⊙
CNR-20N201K	20N201K	130	170	200	180	220	340	200	200	20000	1	2125	5	□
CNR-20N221K	20N221K	140	180	220	198	242	360	200	215	20000	1	2000		□
CNR-20N241K	20N241K	150	200	240	216	264	395	200	235	20000	1	1875		□
CNR-20N271K	20N271K	175	225	270	243	297	455	200	275	20000	1	1625		□
CNR-20N301K	20N301K	195	250	300	270	330	500	200	295	20000	1	1500		□
CNR-20N331K	20N331K	215	275	330	297	363	550	200	320	20000	1	1375		□
CNR-20N361K	20N361K	230	300	360	324	396	595	200	350	20000	1	1375		□
CNR-20N391K	20N391K	250	320	390	351	429	650	200	385	20000	1	1375		□
CNR-20N431K	20N431K	275	350	430	387	473	710	200	425	20000	1	1250		□
CNR-20N471K	20N471K	300	385	470	423	517	775	200	450	20000	1	1125		□
CNR-20N511K	20N511K	320	410	510	459	561	845	200	500	20000	1	1000		□
CNR-20N561K	20N561K	350	460	560	504	616	915	200	520	20000	1	938		□
CNR-20N621K	20N621K	395	510	620	558	682	1020	200	590	15000	1	713		□
CNR-20N681K	20N681K	420	560	680	612	748	1120	200	650	15000	1	688		□
CNR-20N751K	20N751K	465	615	750	675	825	1235	200	725	15000	1	663		□

Related Standards

Symbols	□		⊙			
Approval						

Note : VDE & CQC Certification are under appoaling

Reliability			
Characteristics	Standard	Test Conditions	Specifications
Robustness of terminations	IEC 60068-2-21 Test Ua1	F = 10 N (d ≤ 0.8 mm) ,F = 20 N (d = 1 mm)	$\Delta V/V \leq \pm 10\%$ No visible damage
Solderability	IEC 60068-2-20 Test Ta (Method 1)	T = 235±5 °C, d = 2±0.5s	Approximately ≥ 95%
Resistance to soldering heat	IEC 60068-2-20 Test Tb (Method 1A)	T = 260±5 °C, d = 10±1s	$\Delta V/V \leq \pm 10\%$ No visible damage
Shock	IEC 60068-2-27 Test Ea	Pulse shape: half-sine. a = 490 m/s ² , d = 11ms. N = 6 x 3 shocks	$\Delta V/V \leq \pm 10\%$ No visible damage
Vibration	IEC 60068-2-6 Test Fc Method B4	Frequency range: 10 Hz to 55 Hz ,a = 0.75 mm or 98 m/s ² (whichever is the less), d = 3x2 h	$\Delta V/V \leq \pm 10\%$ No visible damage
Needle flame test	IEC 60695-11-5	Severity: Vertical 10 s	Duration of burning: 5 s max.
Voltage under pulse condition	IEC 61051-2	At class current	As specified in specification
Voltage proof	IEC 61051-2	Metal balls method (4.8.1.2) 2500 V, 60 s	As specified in specification
Pulse current - 8/20 μs	IEC 61051-2	8/20 μs, 10 times, I peak=0.25*Imax	$\Delta V/V \leq \pm 10\%$ No visible damage
Pulse current - 10/1000 μs	IEC 61051-2	10/1000 μs, 10 times, Ipeak = 0.0075* Imax	$\Delta V/V \leq \pm 10\%$ No visible damage
Combination pulse	IEC 60950-1:2013 Annex Q	Additional test: 10 pulses (combination pulse 6KV/3KA), in one direction, 1 per min	$\Delta V/V \leq \pm 10\%$ No visible damage U ≤ 1.1 Uinitial Voltage proof:No breakdown or flashover
Rapid change of temperature	IEC 60068-2-14 Test Na	N = 5 cycles, d = 30 min , θA = -40±3°C, θB = 85±2°C	$\Delta V/V \leq \pm 10\%$ No visible damage
Climatic sequence	IEC 60068-2-2 Test Ba IEC 60068-2-30 Test Db IEC 60068-2-1 Test Aa IEC 60068-2-30 Test Db	Dry heat, Test Ba:16±2h, T = 85±2°C Damp heat, Test Db first cycle :24h, T = 55±2°C Cold, Test Aa :2h, T = -40±3°C Damp heat Test Ba remaining cycles:5 cycle	$\Delta V/V \leq \pm 10\%$ No visible damage RISO ≥ 100MΩ Voltage proof:No breakdown or flashover
Endurance at upper category temperature	IEC 61051-1 (4.21)	T:max temperature as specified , Duration: 1000 h, Voltage: max. a.c. voltage	$\Delta V/V \leq \pm 10\%$ No visible damage R ≥ 1000MΩ U ≤ 1,1 Uinitial



Reliability

Characteristics	Standard	Test Conditions	Specifications
Damp heat (Steady state)	IEC 60068-2-78 Test Ca	T = 40±2°C, RH = 93(+2/-3)%, 56d , 4 specimens:No voltage applied , Other 4 specimens:Applied voltage: 10% of the max. d.c. voltage	$\Delta V/V \leq \pm 10\%$ RISO $\geq 100M\Omega$
Maximum Peak Current	Specification Standard	$I_{max}, 8/20 \mu s, 1 \text{ time } \frac{V_{1mA \text{ at } 85^\circ C} - V_{1mA \text{ at } 25^\circ C}}{V_{1mA \text{ at } 25^\circ C}} \times \frac{1}{60} \times 100(\%/^\circ C)$	$-0.05 \leq TC \leq 0.05(\%/^\circ C)$
Nominal Discharge Current Test	UL1449 4th	Nominal Discharge Current (In), 8/20 μs , 15 times	$\Delta V/V \leq \pm 10\%$ No visible damage
Varistor Voltage Temp. Coefficient	Specification Standard	V1mA at -40°C, 85°C, 25°C	$\Delta V/V \leq \pm 10\%$ No visible damage
High Temperature Storage	IEC60068-2-2	1000h, T = 85±2°C	$\Delta V/V \leq \pm 10\%$ No visible damage
Max. Energy	Specification Standard	10/1000 μs , 1 tmes, Max. Energy	$\Delta V/V \leq \pm 10\%$ No visible damage
Operating duty cycle test *	UL 1449	6 kV/3 kA combination wave surges, phase angle of 90 (+0, -15) degrees, npositive polarity 8 times, negative polarity 7 times, interval of 60s.	$\Delta V/V \leq \pm 10\%$ No visible damage
Surge Immunity Test*	IEC 61000-4-5	4kV/2kA combination wave surges, phase angle of 90 (+0, -15) degrees, npositive polarity 20times, negative polarity 20times, interval of 60s.	$\Delta V/V \leq \pm 10\%$ No visible damage

* (According to customer requirements to meet the test items)

Impulse Life Time Rating Curves

CNR-05N180K to CNR-05N680K

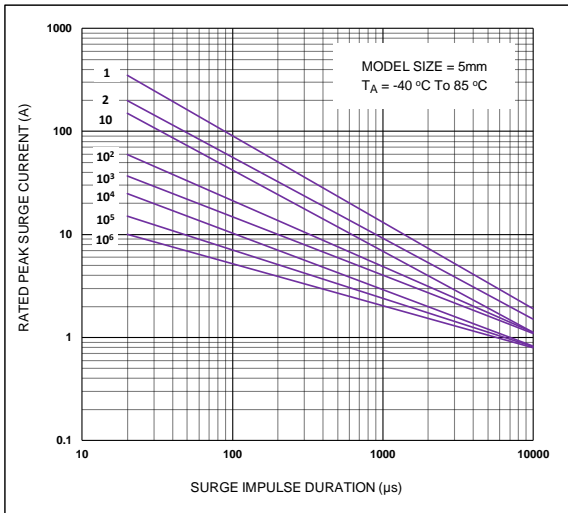

CNR-05N201K to CNR-05N751K

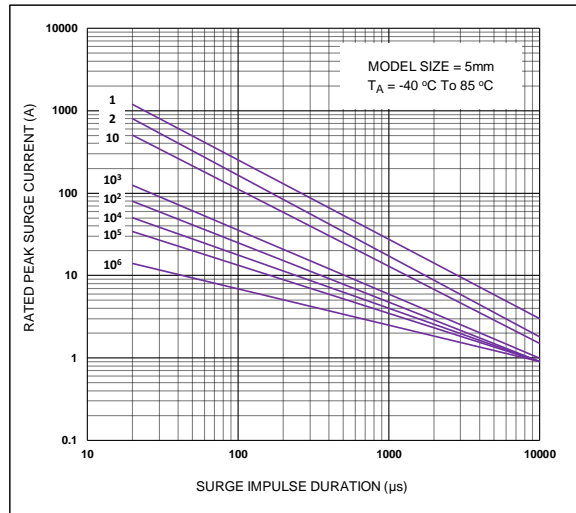

CNR-07N180K to CNR-07N680K

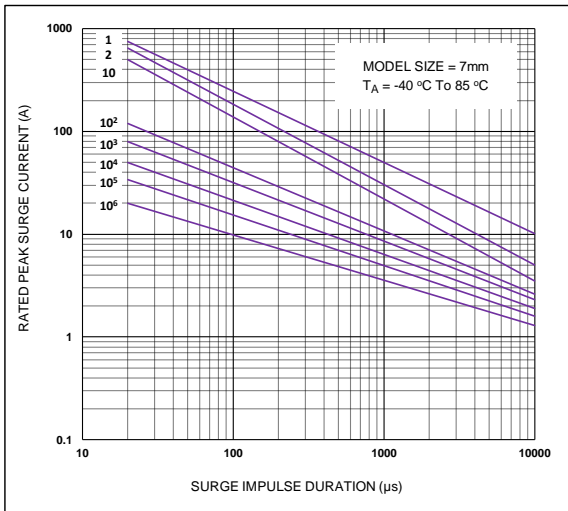

CNR-07N201K to CNR-07N751K

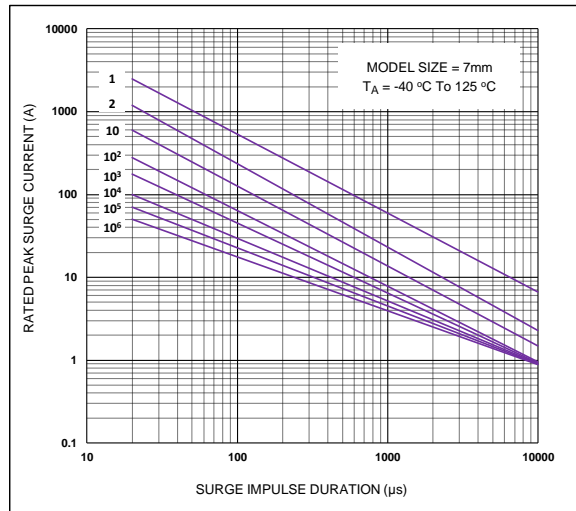

Impulse Life Time Rating Curves

CNR-10N180K to CNR-10N680K

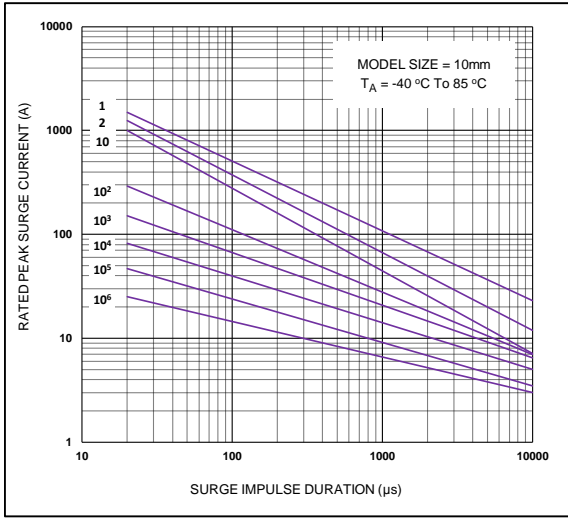

CNR-10N201K to CNR-10N112K

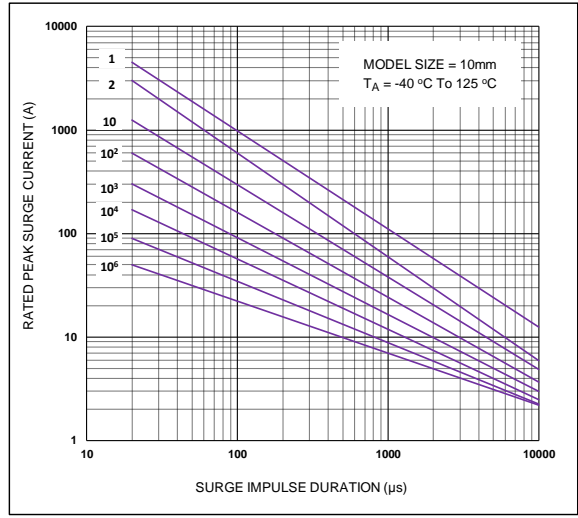

CNR-14N180K to CNR-14N680K

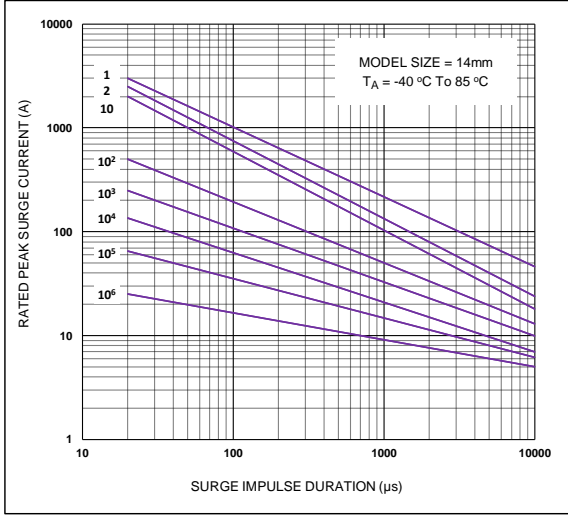

CNR-14N201K to CNR-14N561K

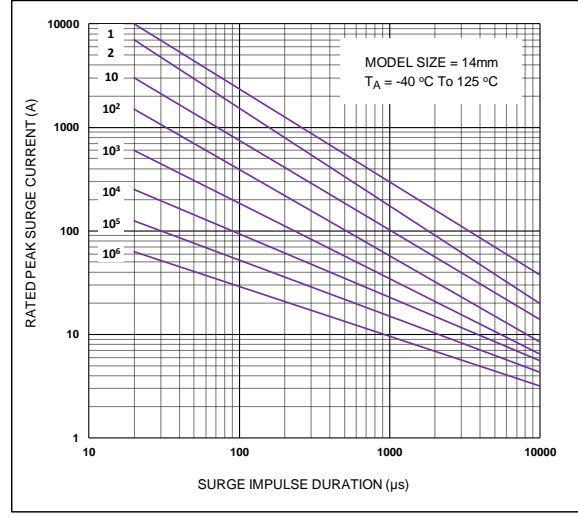

Impulse Life Time Rating Curves

CNR-14N621K to CNR-14N112K

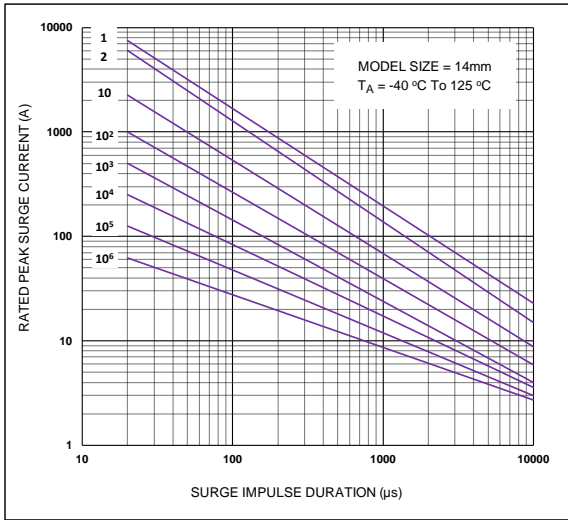

CNR-18N180K to CNR-18N680K

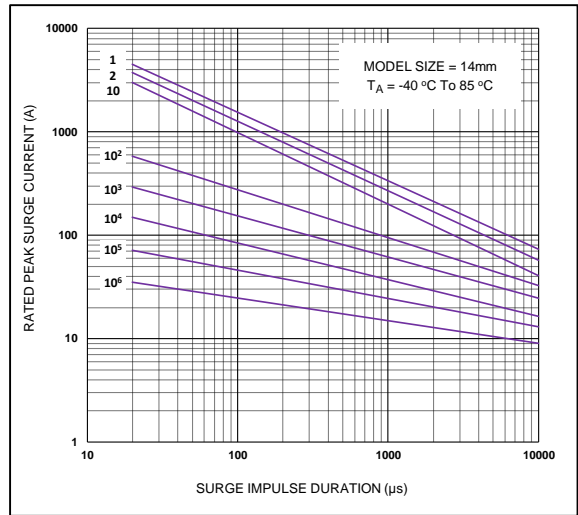

CNR-18N201K to CNR-18N112K

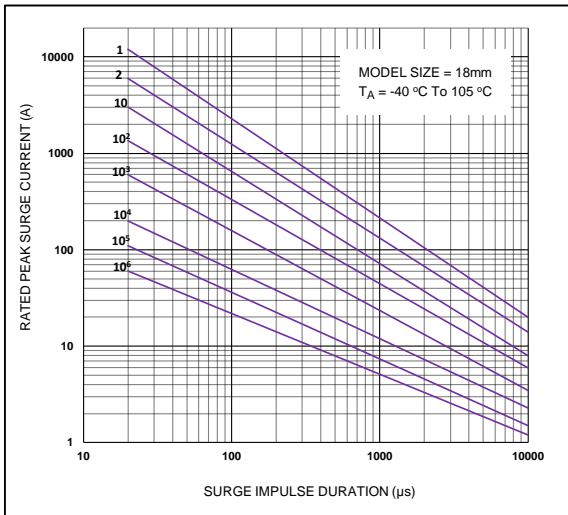

CNR-20N180K to CNR-20N680K

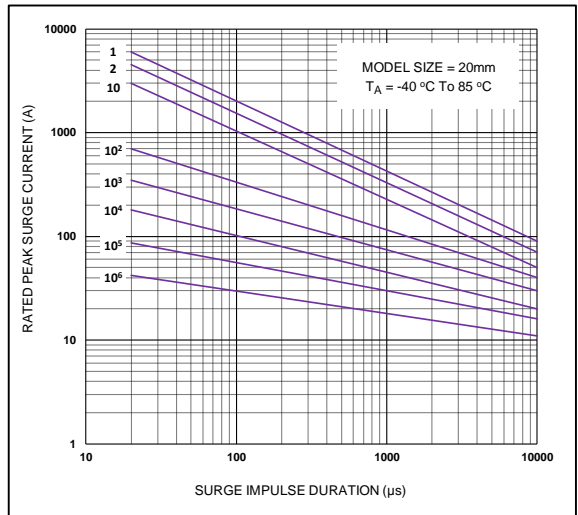

Impulse Life Time Rating Curves

CNR-20N201K to CNR-20N561K

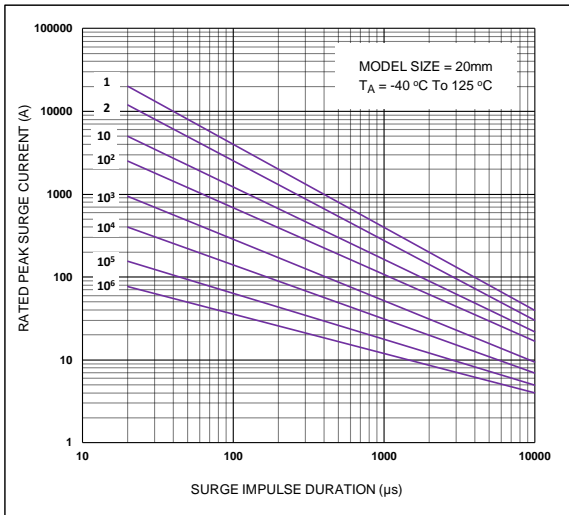

CNR-20N621K to CNR-20N112K

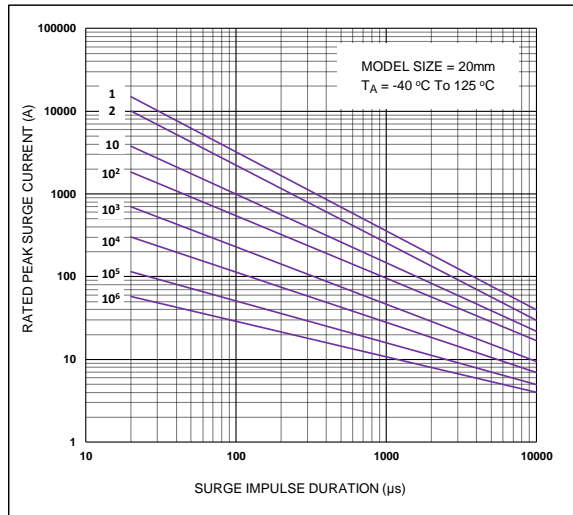



CNR-05N180K to CNR-05N680K V-I Curves

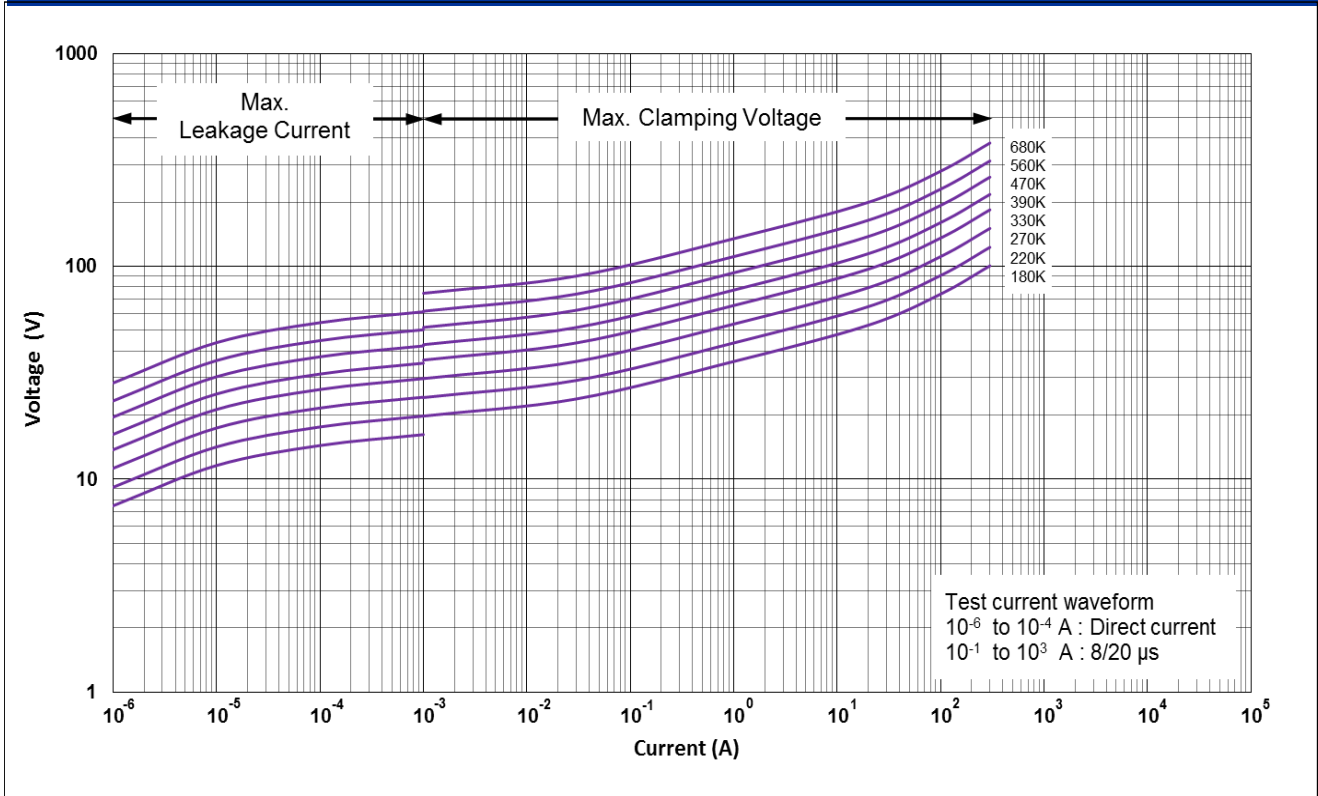

CNR-05N201K to CNR-05N751K V-I Curves

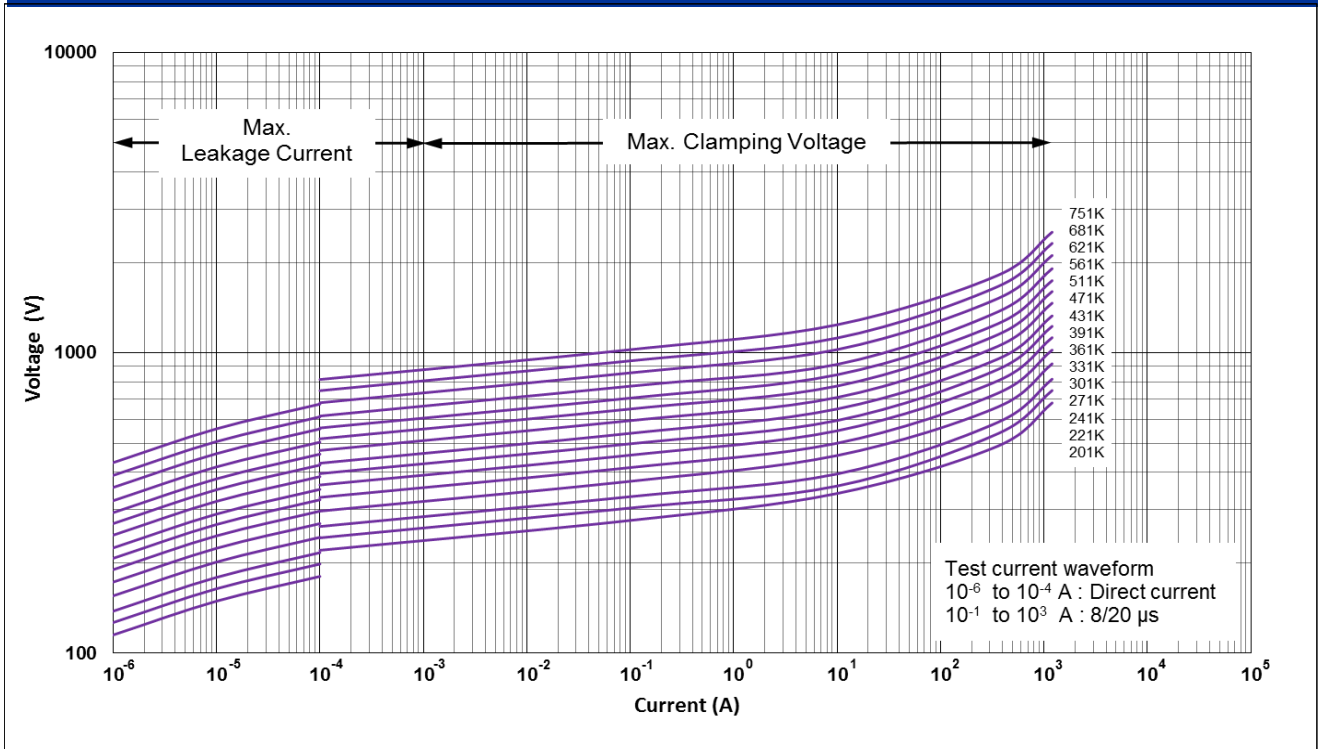



CNR-07N180K to CNR-07N680K V-I Curves

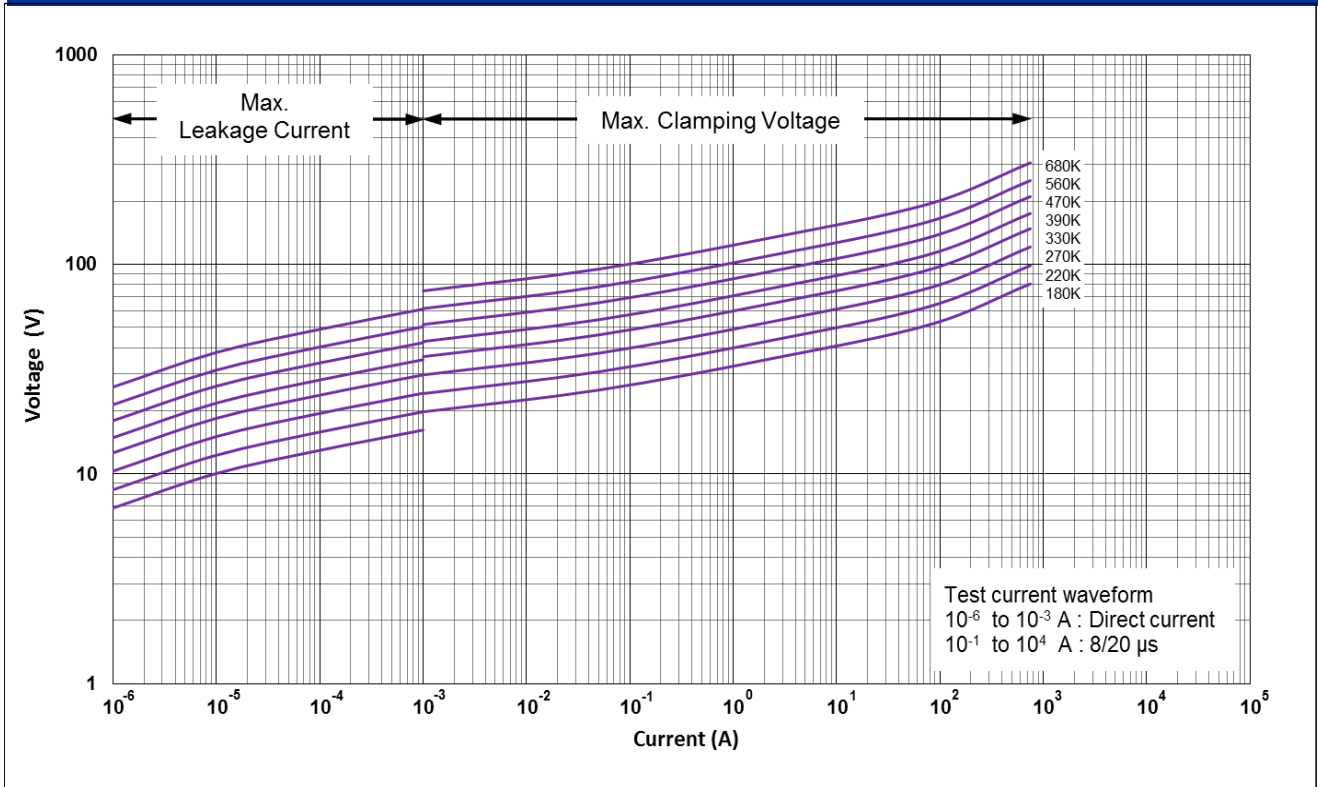

CNR-07N201K to CNR-07N751K V-I Curves

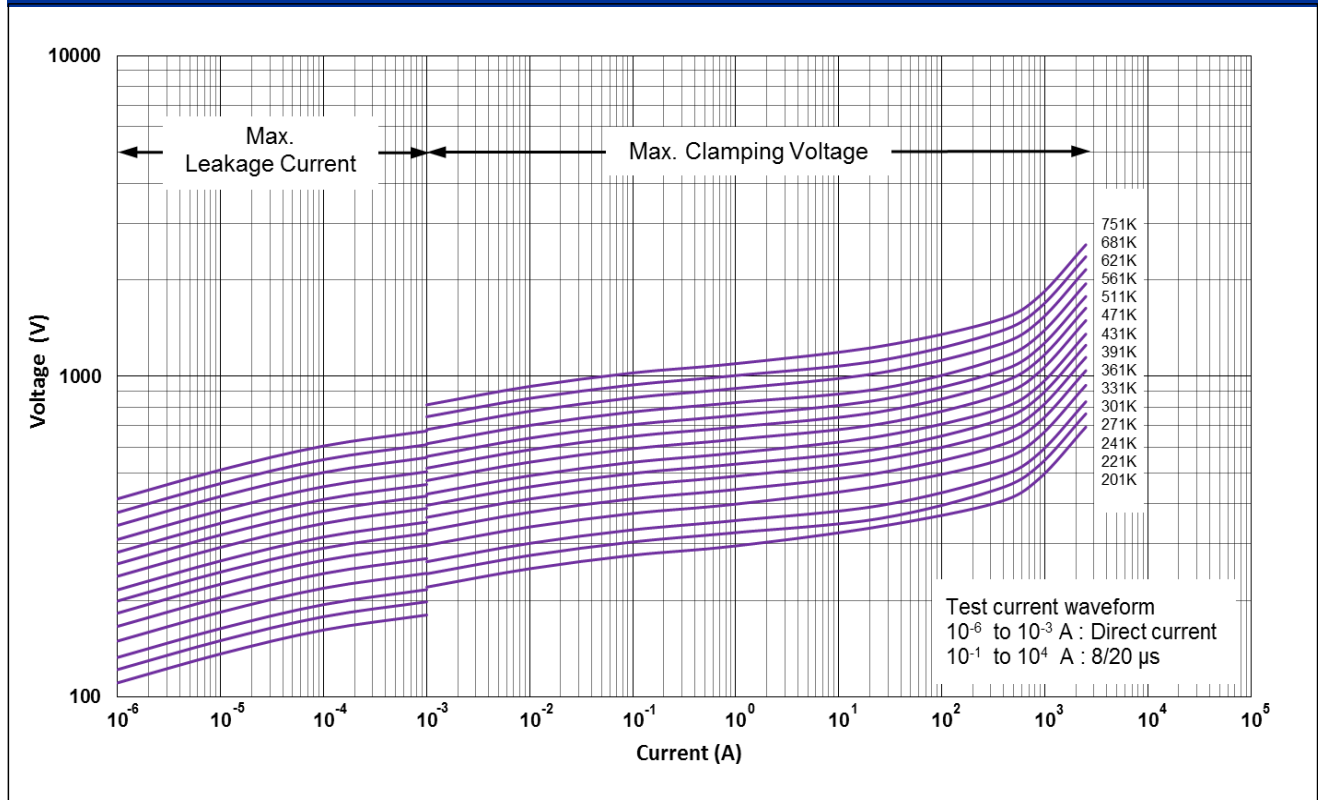



CNR-10N180K to CNR-10N680K V-I Curves

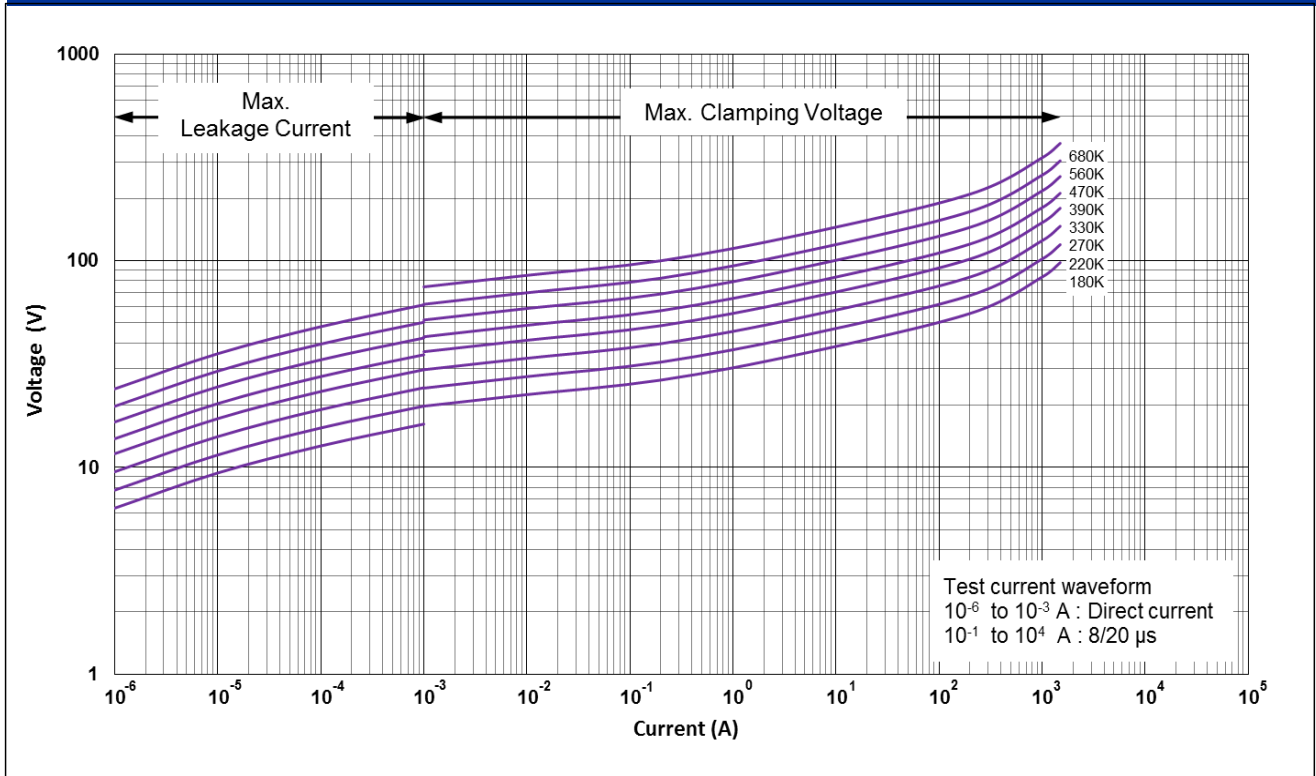

CNR-10N201K to CNR-10N751K V-I Curves

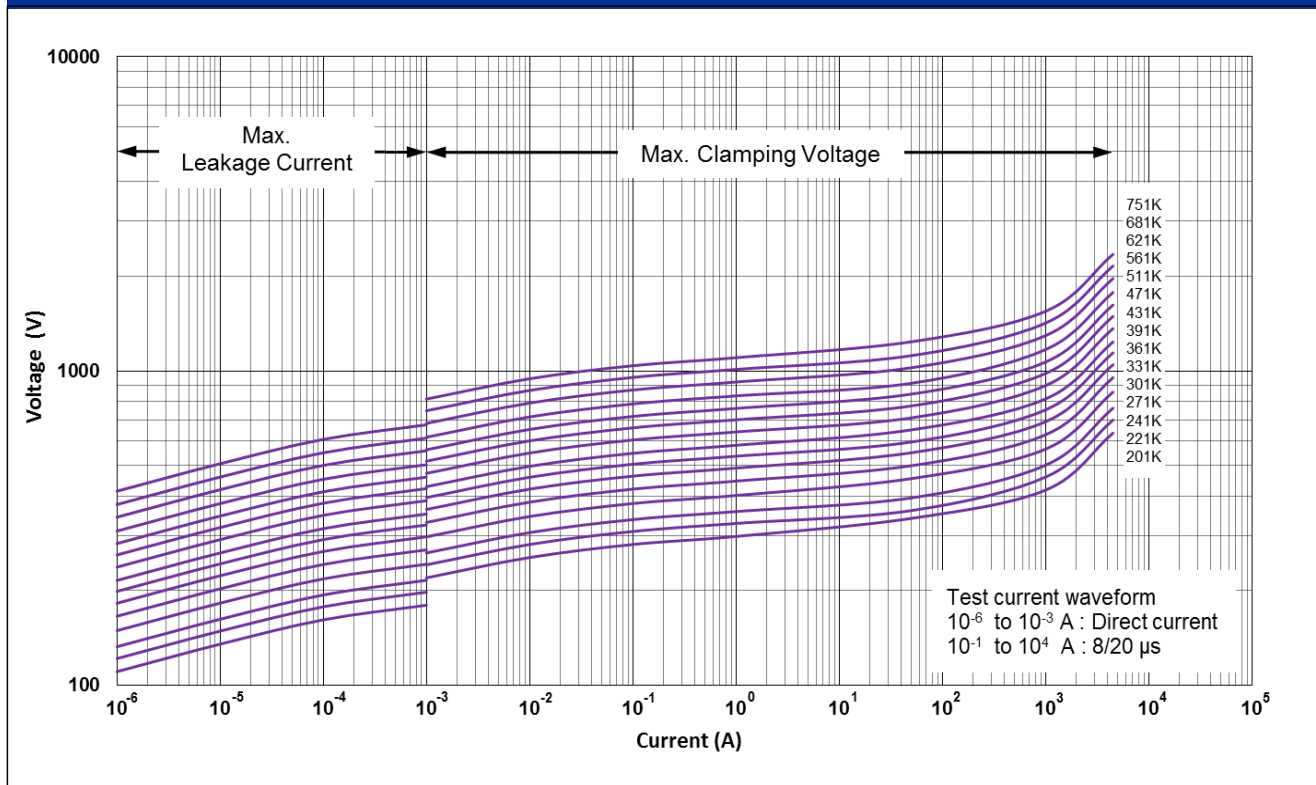



CNR-14N180K to CNR-14N680K V-I Curves

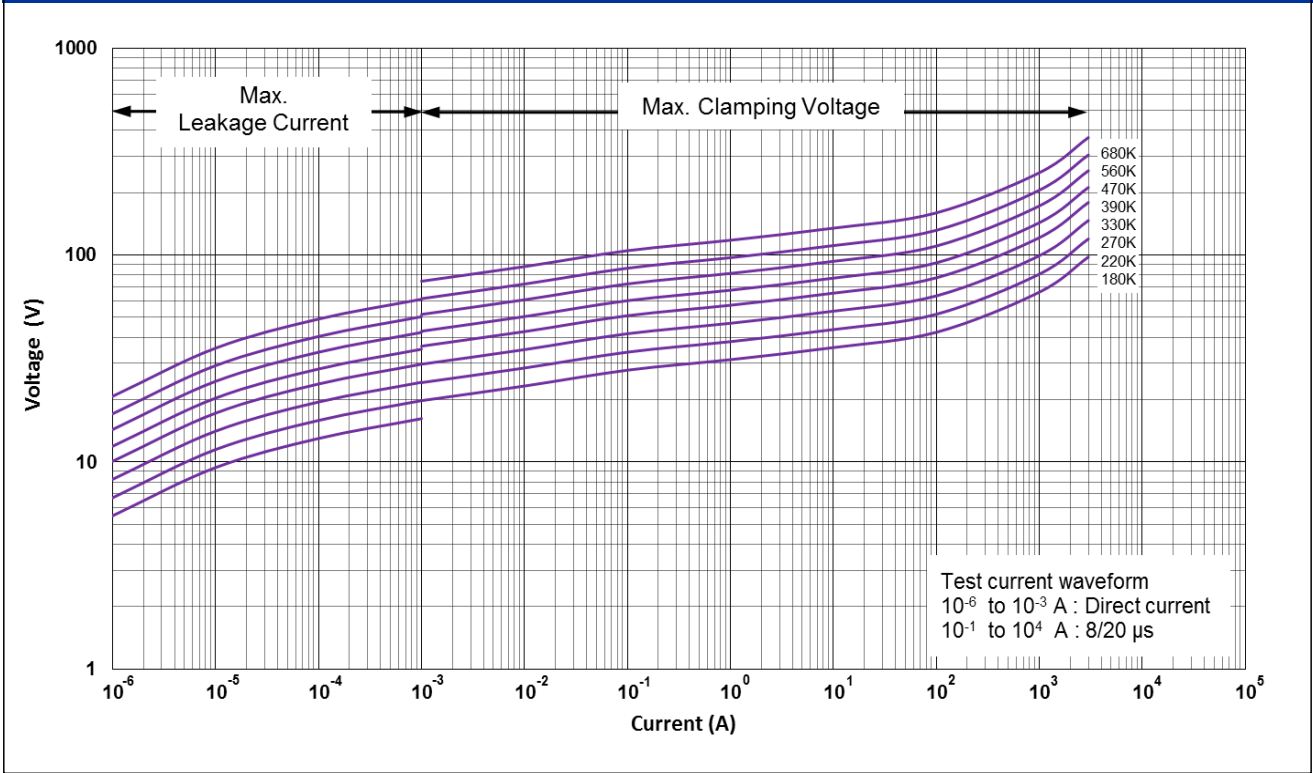

CNR-14N201K to CNR-14N561K V-I Curves

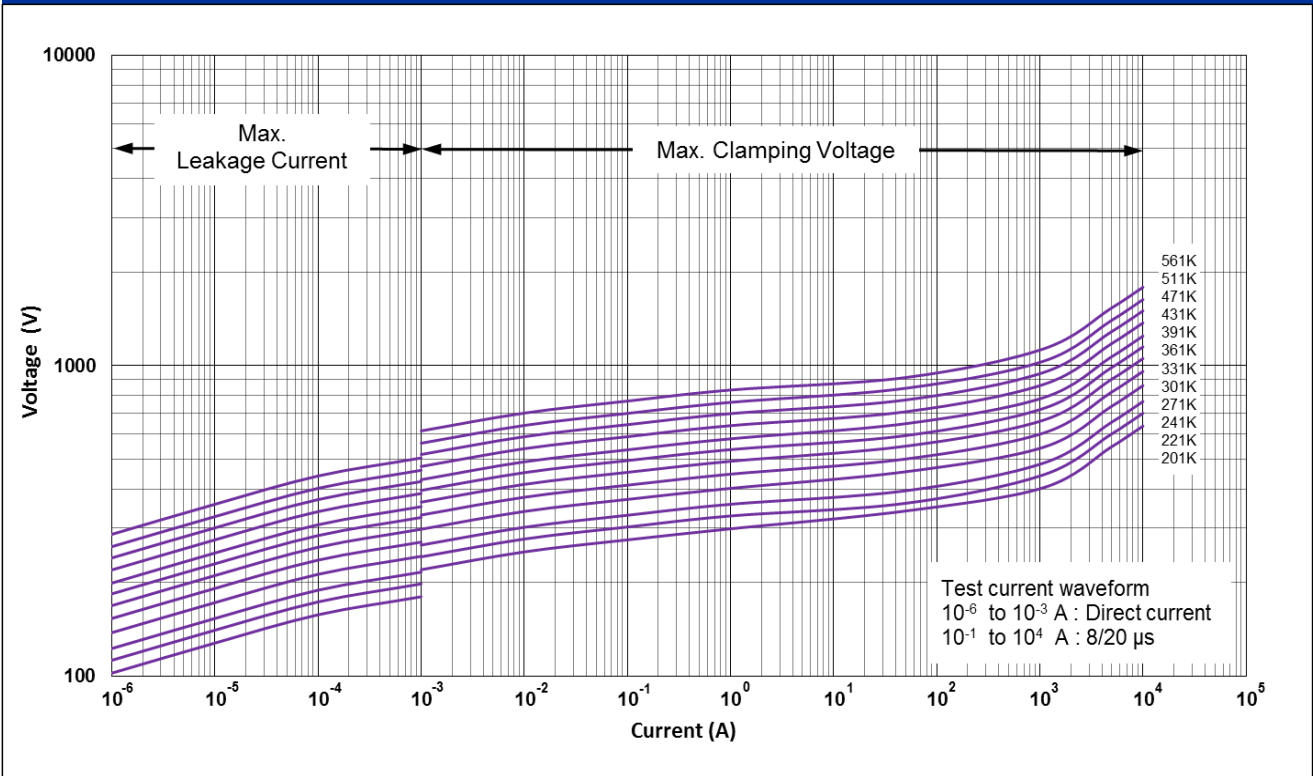



CNR-18N621K to CNR-18N751K V-I Curves

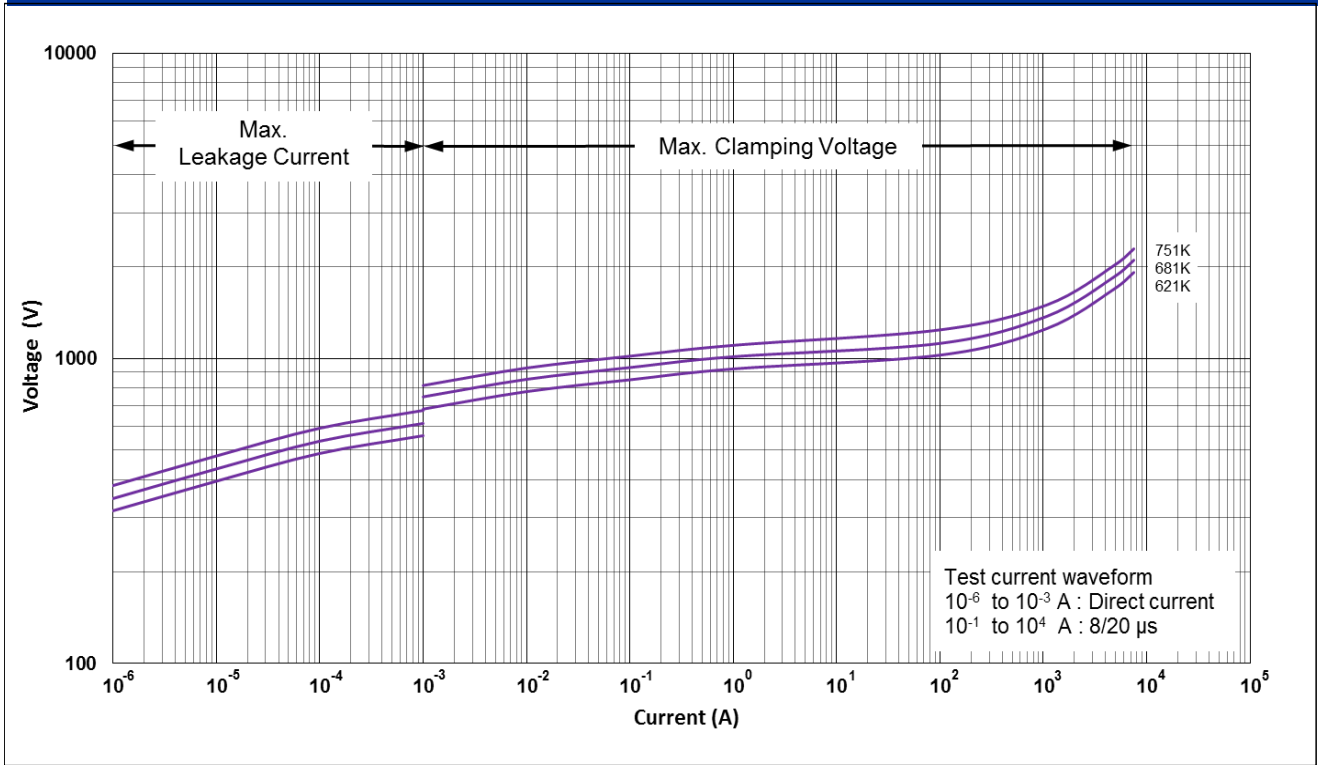

CNR-18N180K to CNR-18N680K V-I Curves

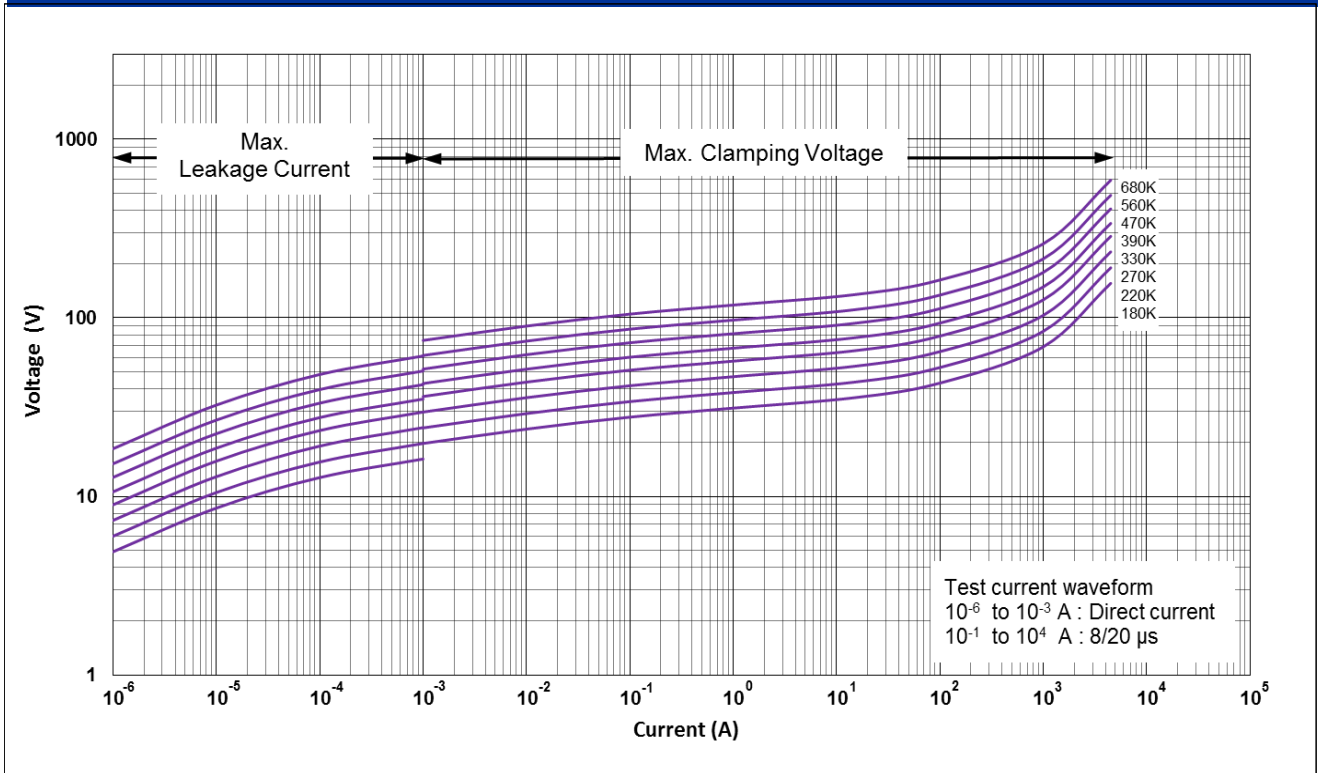



CNR-18N201K to CNR-18N561K V-I Curves

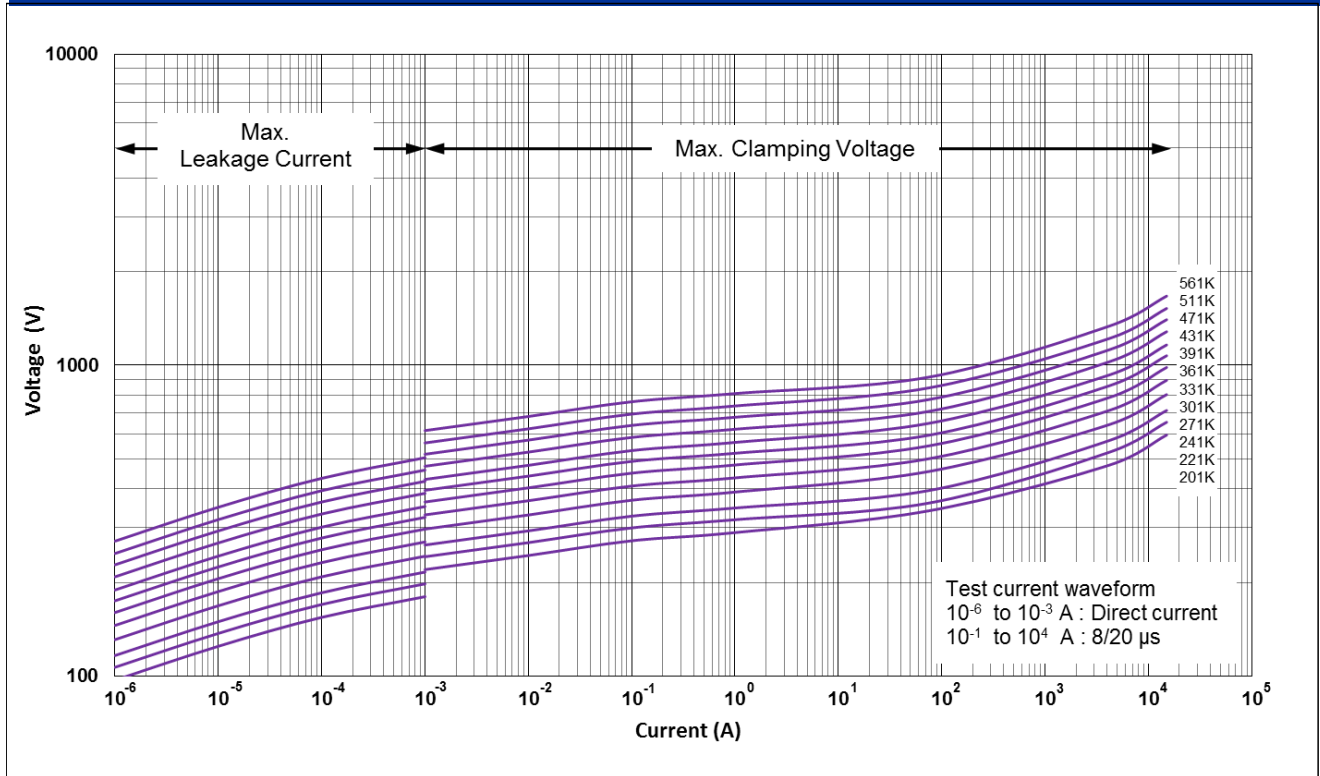

CNR-18N621K to CNR-18N751K V-I Curves

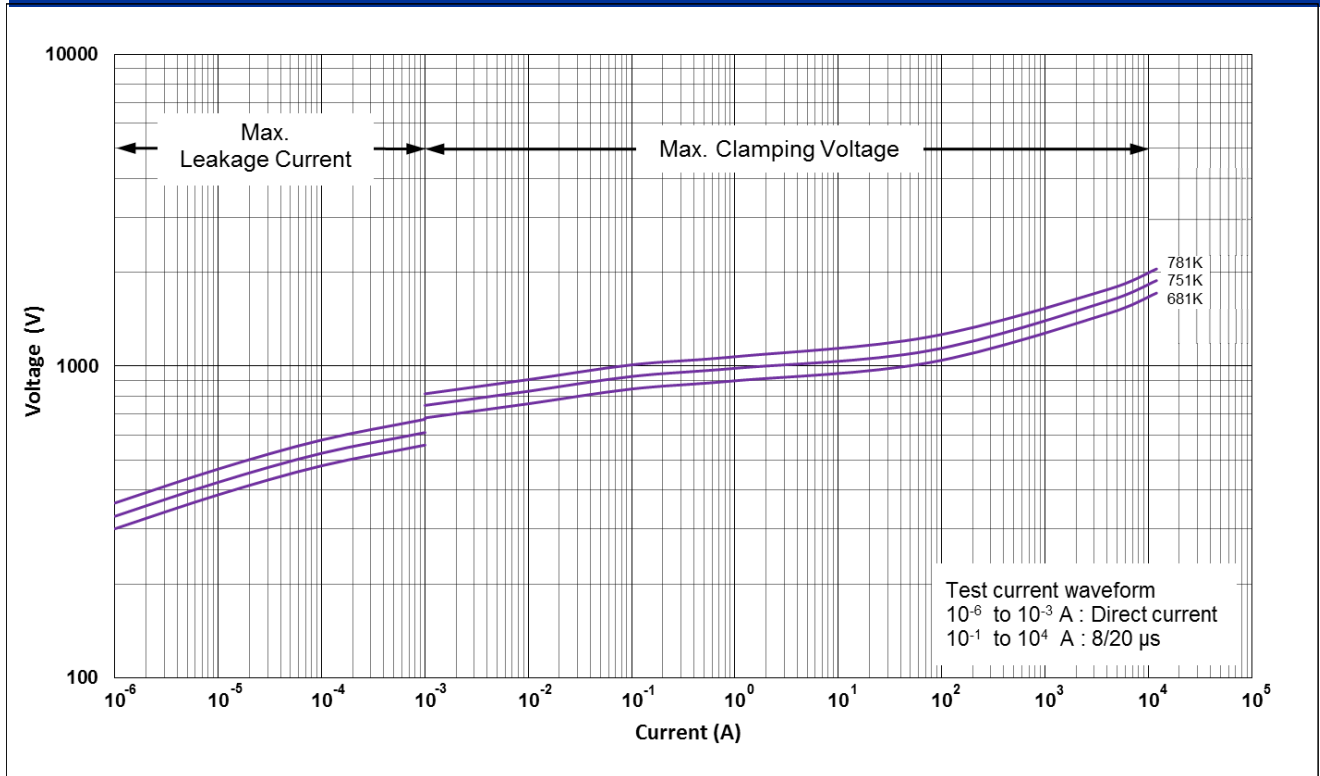



CNR-20N180K to CNR-20N680K V-I Curves

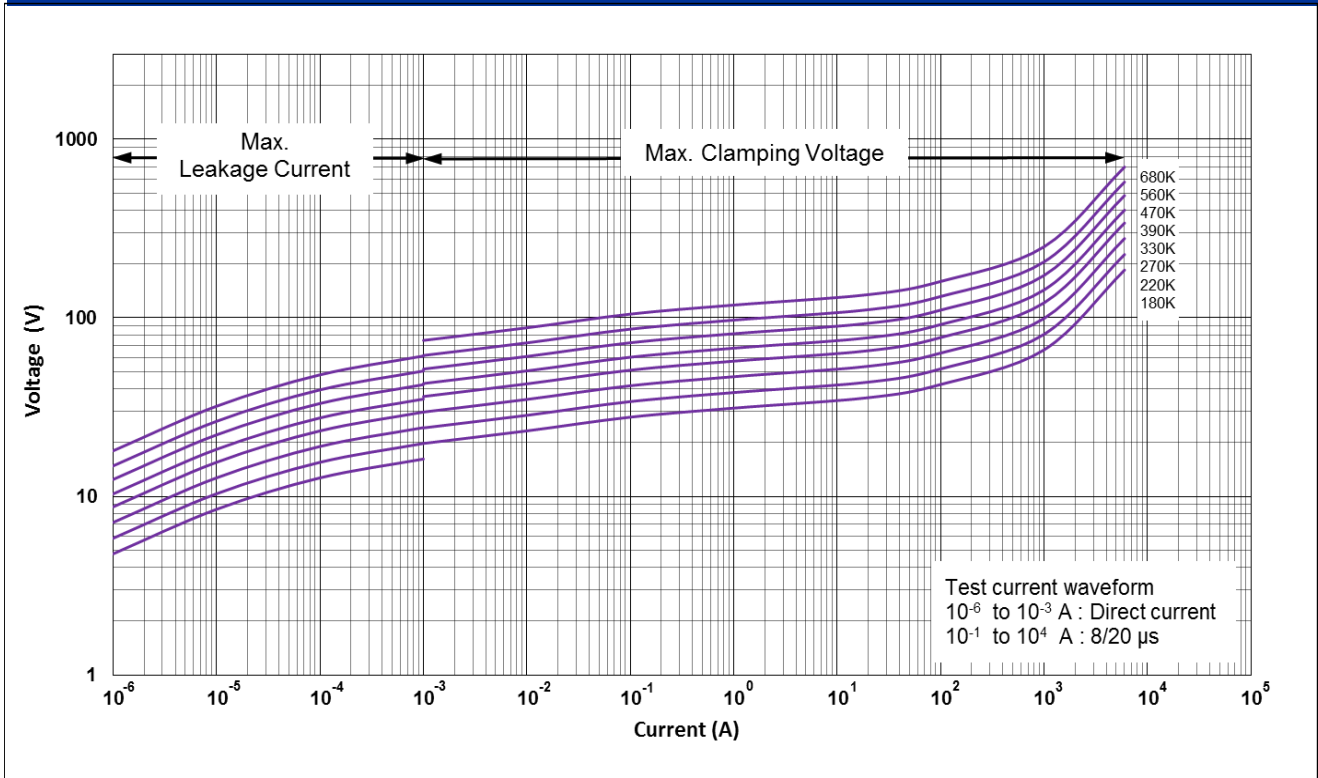

CNR-20N201K to CNR-20N561K V-I Curves

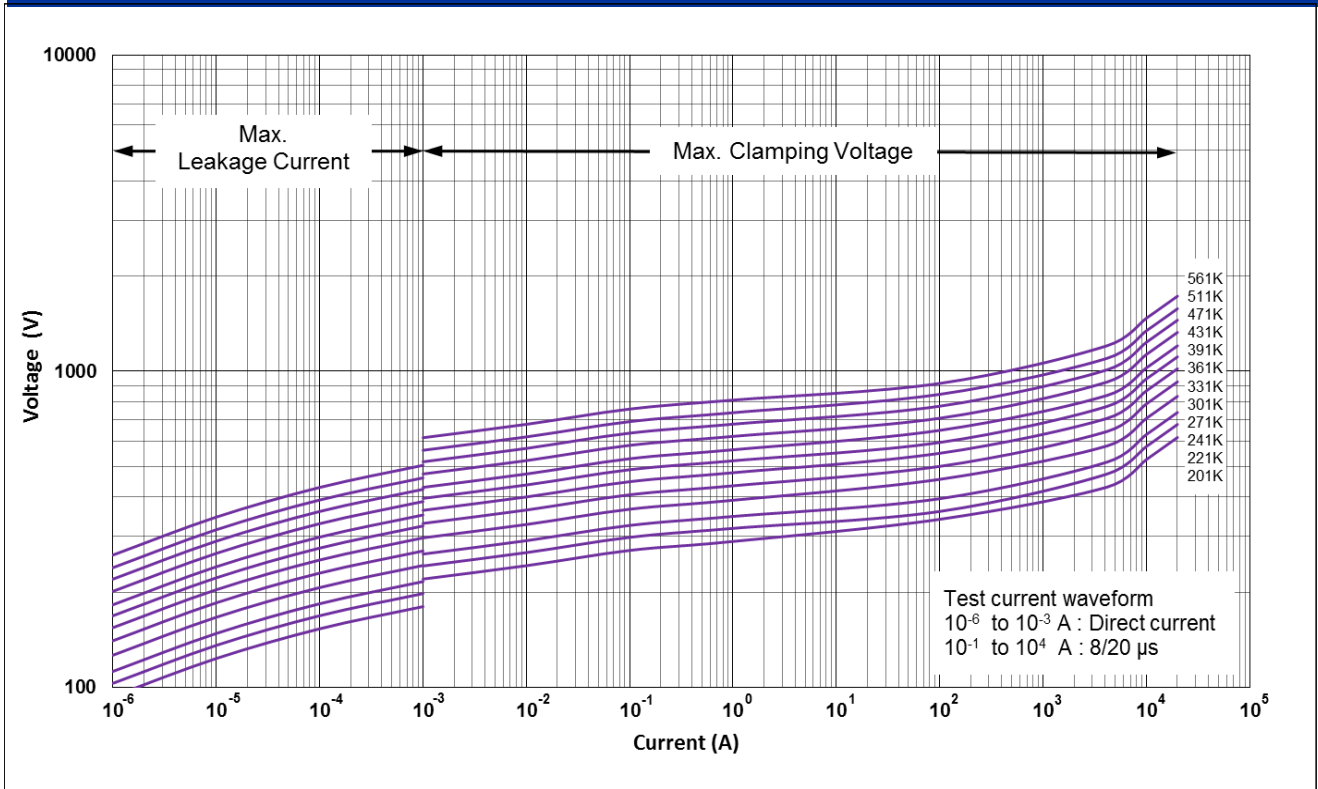



CNR-20N621K to CNR-20N751K V-I Curves

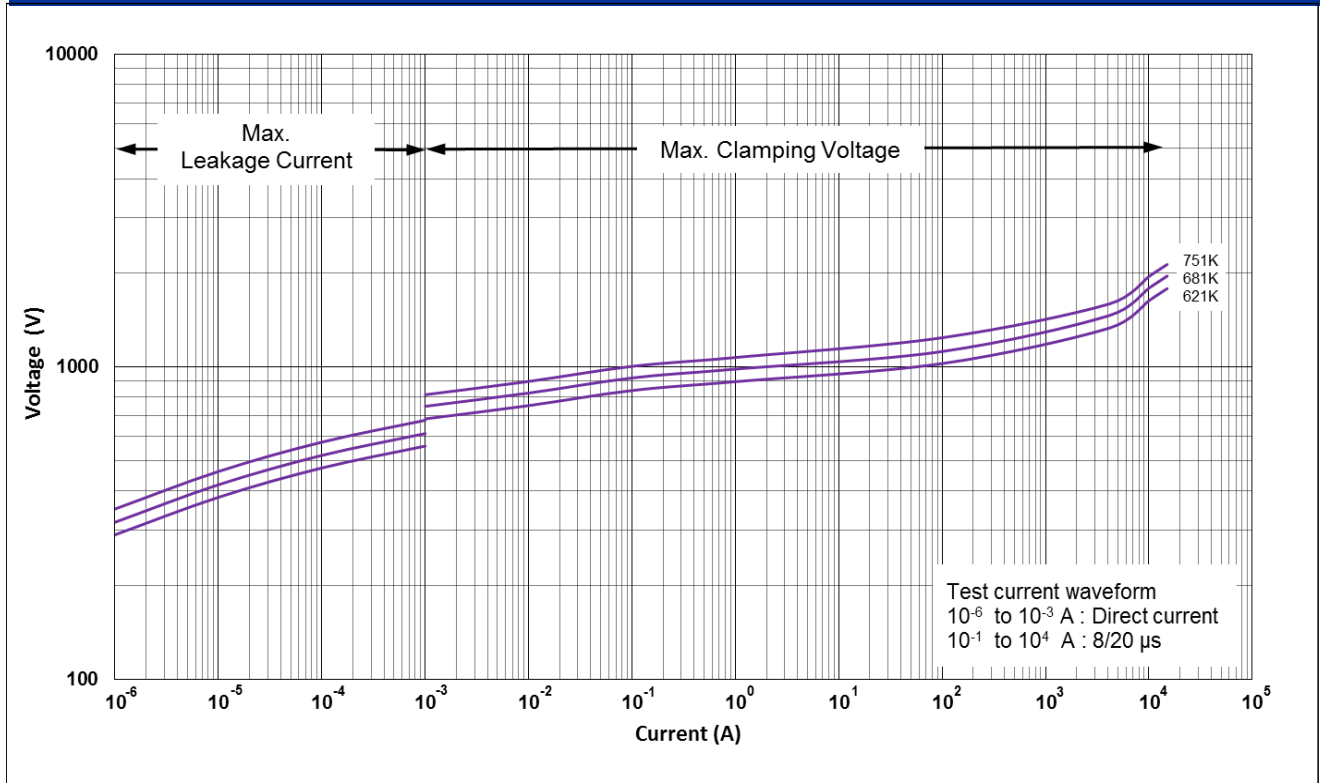

Power Derating Curve

Should transients occur in rapid succession, the average power dissipation is the energy (watt-seconds) per pulse times the number of pulses per second. The power so developed must be with the specifications shown on the Device Ratings and Specifications Table for the specific device. The operating values of a MOV need to be derated at high temperatures as shown above. Because varistors only dissipate a relatively small amount of average power they are not suitable for repetitive applications that involve substantial amounts of average power dissipation.

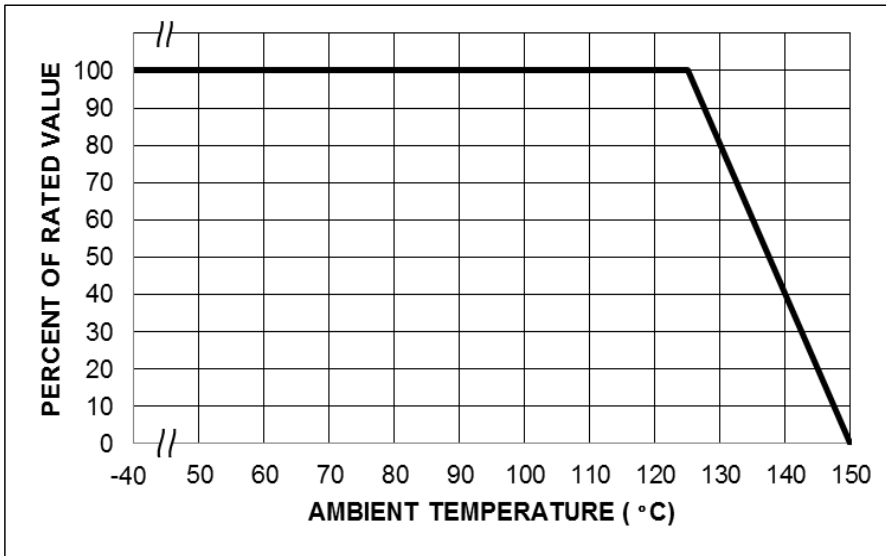

Surge Current Standard Waveform

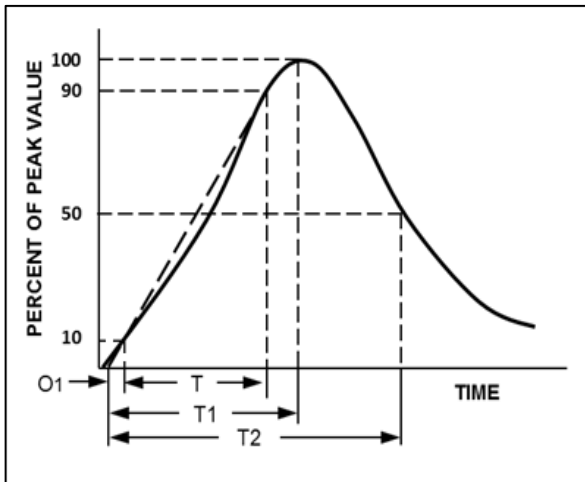

O1 = Virtual Origin of Wave
 T = Time from 10% to 90% of Peak
 T1 = Rise Time = 1.25 x T
 T2 = Decay Time
 Example - For an 8/20 μs Current Waveform:
 8μs = T1 = Rise Time
 20μs = T2 = Decay Time

Product Dimensions

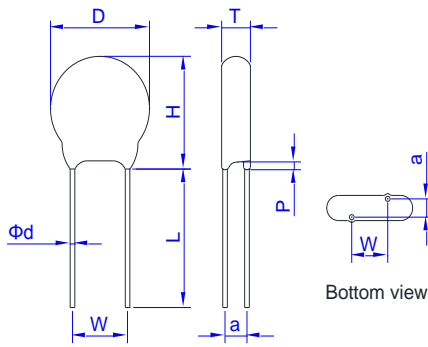

Fig 1. Straight Lead

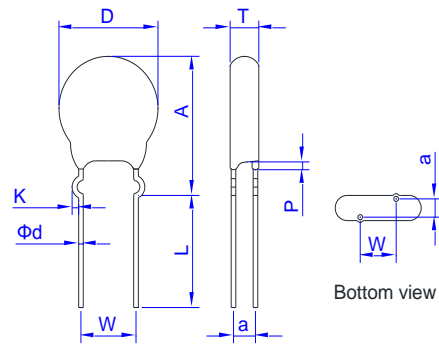

Fig 2. Outside Kink Lead

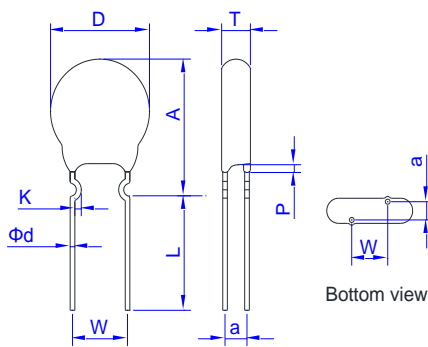

Fig 3. Inside Kink Lead

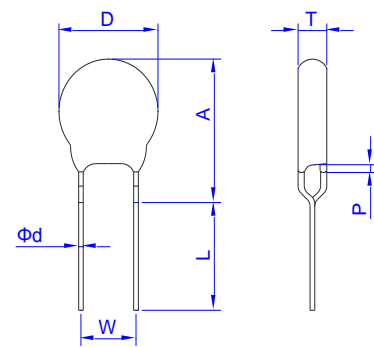

Fig 4. In Line Kink Lead

Dimension Table

Unit:mm

Symbol	Model	05N		07N		10N		14N		18N		20N	
		Min.	Max.	Min.	Max.	Min.	Max.	Min.	Max.	Min.	Max.	Min.	Max.
D		5.5	7.5	7.5	9.0	10.5	14.0	13.5	17.5	18.5	23.0	19.5	25.0
H		-	10.0	-	12.0	-	17.0	-	20.5	-	26.0	-	28.0
W		4.0	6.0	4.0	6.0	6.5	8.5	6.5	8.5	6.5	8.5	9.0	11.0
Φd		0.55	0.65	0.55	0.65	0.75	0.85	0.75	0.85	0.75	0.85	0.95	1.05
P(max.)		3.0											
L(min)		25.0											
K(Kink Lead)		0.8	1.6	0.8	1.6	1.0	1.8	1.0	1.8	1.0	1.8	1.0	1.8
A(max.)	180K-271K	-	13.0	-	15.0	-	19.5	-	22.5	-	26.5	-	30.0
	>271K	-	13.0	-	15.0	-	20.5	-	23.5	-	27.0	-	31.0
T		See Tmax table											

* Short Cut Lead type TTXX the lead length (L) can 3.0~15mm (except 20N dia <10mm), see Ordering Note.

* * a value see T max. table



T max. Table								Unit:mm							
Model	05N	07N	10N	14N	18N	20N	a(±1.0)	Model	05N	07N	10N	14N	18N	20N	a(±1.0)
180K	4.7	4.7	5.3	5.3	5.3	5.3	1.5	271K	6.1	6.6	6.6	6.6	6.6	6.6	2.3
220K	5.1	5.1	5.6	5.6	5.6	5.6	1.7	301K	6.2	6.8	6.8	6.8	6.8	6.8	2.5
270K	5.3	5.3	5.9	5.9	5.9	5.9	1.8	331K	6.4	7	7	7	7	7	2.7
330K	4.7	4.7	5.3	5.3	5.3	5.3	1.9	361K	6.5	7.3	7.3	7.3	7.3	7.3	2.8
390K	4.9	4.9	5.5	5.5	5.5	5.5	1.9	391K	6.8	7.5	7.5	7.5	7.5	7.5	3
470K	5.2	5.2	5.8	5.8	5.8	5.8	2.1	431K	7.1	7.8	7.8	7.8	7.8	7.8	3.2
560K	5.6	5.6	6.1	6.1	6.1	6.1	2.3	471K	7.4	8.1	8.1	8.1	8.1	8.1	3.4
680K	6	6	6.5	6.5	6.5	6.5	2.6	511K	7.8	8.2	8.2	8.2	8.2	8.2	3.7
201K	5.1	6.2	6.2	6.2	6.2	6.2	2	561K	8.2	8.5	8.5	8.5	8.5	8.5	3.9
221K	5.3	6.3	6.3	6.3	6.3	6.3	2.1	621K	8.4	8.8	8.8	8.8	8.8	8.8	4.3
241K	5.4	6.5	6.5	6.5	6.5	6.5	2.2	681K	8.7	8.9	8.9	8.9	8.9	8.9	4.7
								751K	9	9.2	9.2	9.2	9.2	9.2	5.1

Tape and Reel Specifications

● Radial devices on tape are supplied with kinked leads, straight leads or in-line leads

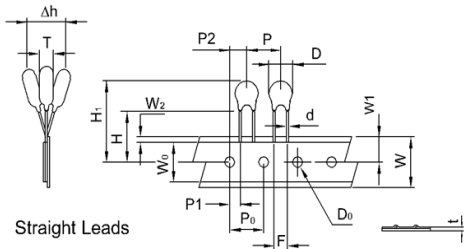

Figure: A

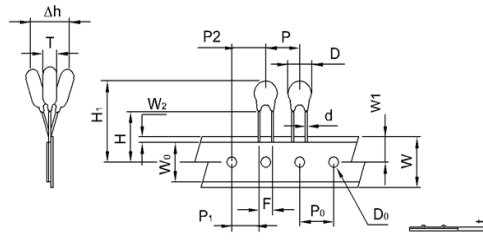

Figure: B

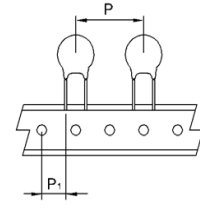

Figure: C

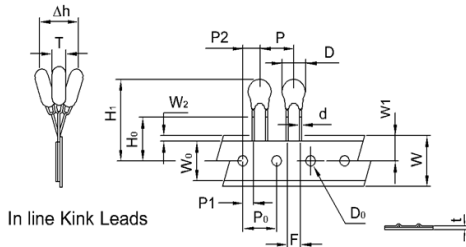

Figure: D

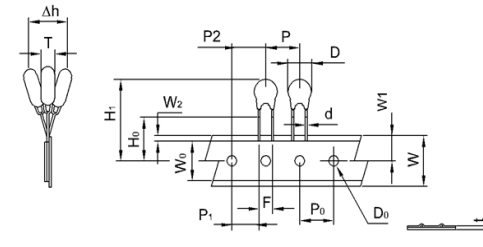

Figure: E

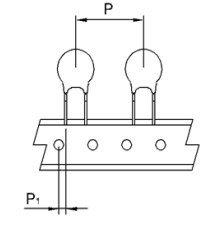

Figure: F

Symbol	Description	Model Size					
		05N	07N	10N	10N	14N	14N
P	Pitch of Component	12.7±1.0	12.7±1.0	12.7±1.0	15.0±1.0	25.4±1.0	30.0±1.0
P ₀	Feed Hole Pitch	12.7±0.2	12.7±0.2	12.7±0.2	15.0±0.2	12.7±0.2	15.0±0.2
P ₁	Feed Hole Center to Pitch	3.85±0.7	3.85±0.7	8.95±0.7	3.75±0.7	8.95±0.7	3.75±0.7
P ₂	Hole Center to Component Center	6.35±0.7	6.35±0.7	12.7±0.7	7.5±0.7	12.7±0.7	7.5±0.7
F	Lead to Lead Distance	5.0±0.8	5.0±0.8	7.5±0.8	7.5±0.8	7.5±0.8	7.5±0.8
△h	Component Alignment	2.0max	2.0max	2.0max	2.0max	2.0max	2.0max
W	Tape Width	18.0+1.0	18.0+1.0	18.0+1.0	18.0+1.0	18.0+1.0	18.0+1.0
		18.0-0.5	18.0-0.5	18.0-0.5	18.0-0.5	18.0-0.5	18.0-0.5
W ₀	Hold Down Tape Width	5.0 Min.	5.0 Min.	5.0 Min.	5.0 Min.	5.0 Min.	5.0 Min.
W ₁	Hole Position	9.0+0.75	9.0+0.75	9.0+0.75	9.0+0.75	9.0+0.75	9.0+0.75
		9.0-0.5	9.0-0.5	9.0-0.5	9.0-0.5	9.0-0.5	9.0-0.5
W ₂	Hold Down Tape Position	3.0 Max	3.0 Max	3.0 Max	3.0 Max	3.0 Max	3.0 Max
H	Height from Tape Center to Component Base	18.0+2.0	18.0+2.0	18.0+2.0	18.0+2.0	18.0+2.0	18.0+2.0
		18.0-0.0	18.0-0.0	18.0-0.0	18.0-0.0	18.0-0.0	18.0-0.0
H ₀	Seating Plane Height	16.0±0.5	16.0±0.5	16.0±0.5	16.0±0.5	16.0±0.5	16.0±0.5
H ₁	Component Height	32.0 Max.	32.0 Max.	36.0 Max.	36.0 Max.	40.0 Max.	40.0 Max.
D ₀	Feed Hole Diameter	4.0±0.2	4.0±0.2	4.0±0.2	4.0±0.2	4.0±0.2	4.0±0.2
t	Total Tape Thickness	0.7±0.2	0.7±0.2	0.7±0.2	0.7±0.2	0.7±0.2	0.7±0.2
L	Length Clipped Lead	11.0 Max	11.0 Max	11.0 Max	11.0 Max	11.0 Max	11.0 Max
Figure		A, D	A, D	B, E	A, D	C	F

Tape and Reel Specifications

- Radial devices on tape are supplied with kinked leads, straight leads or in-line leads

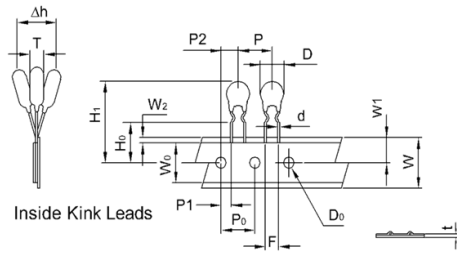

Figure: A

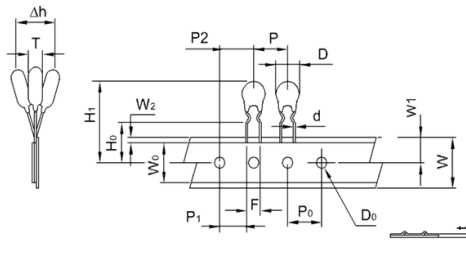

Figure: B

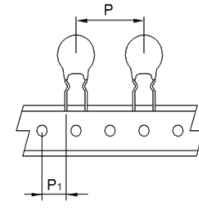

Figure: C

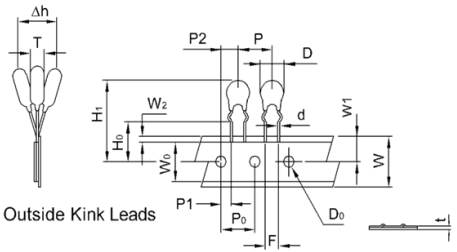

Figure: D

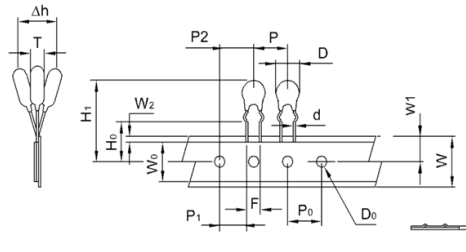

Figure: E

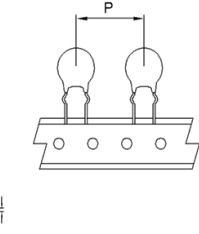

Figure: F

Symbol	Description	Model Size					
		05N	07N	10N	10N	14N	14N
P	Pitch of Component	12.7±1.0	12.7±1.0	12.7±1.0	15.0±1.0	25.4±1.0	30.0±1.0
P ₀	Feed Hole Pitch	12.7±0.2	12.7±0.2	12.7±0.2	15.0±0.2	12.7±0.2	15.0±0.2
P ₁	Feed Hole Center to Pitch	3.85±0.7	3.85±0.7	8.95±0.7	3.75±0.7	8.95±0.7	3.75±0.7
P ₂	Hole Center to Component Center	6.35±0.7	6.35±0.7	12.7±0.7	7.5±0.7	12.7±0.7	7.5±0.7
F	Lead to Lead Distance	5.0±0.8	5.0±0.8	7.5±0.8	7.5±0.8	7.5±0.8	7.5±0.8
△h	Component Alignment	2.0max	2.0max	2.0max	2.0max	2.0max	2.0max
W	Tape Width	18.0+1.0	18.0+1.0	18.0+1.0	18.0+1.0	18.0+1.0	18.0+1.0
		18.0-0.5	18.0-0.5	18.0-0.5	18.0-0.5	18.0-0.5	18.0-0.5
W ₀	Hold Down Tape Width	5.0 Min.	5.0 Min.	5.0 Min.	5.0 Min.	5.0 Min.	5.0 Min.
W ₁	Hole Position	9.0+0.75	9.0+0.75	9.0+0.75	9.0+0.75	9.0+0.75	9.0+0.75
		9.0-0.5	9.0-0.5	9.0-0.5	9.0-0.5	9.0-0.5	9.0-0.5
W ₂	Hold Down Tape Position	3.0 Max	3.0 Max	3.0 Max	3.0 Max	3.0 Max	3.0 Max
H	Height from Tape Center to Component Base	18.0+2.0	18.0+2.0	18.0+2.0	18.0+2.0	18.0+2.0	18.0+2.0
		18.0-0.0	18.0-0.0	18.0-0.0	18.0-0.0	18.0-0.0	18.0-0.0
H ₀	Seating Plane Height	16.0±0.5	16.0±0.5	16.0±0.5	16.0±0.5	16.0±0.5	16.0±0.5
H ₁	Component Height	29.0 Max.	32.0 Max.	36.0 Max.	36.0 Max.	40.0 Max.	40.0 Max.
D ₀	Feed Hole Diameter	4.0±0.2	4.0±0.2	4.0±0.2	4.0±0.2	4.0±0.2	4.0±0.2
t	Total Tape Thickness	0.7±0.2	0.7±0.2	0.7±0.2	0.7±0.2	0.7±0.2	0.7±0.2
L	Length Clipped Lead	11.0 Max	11.0 Max	11.0 Max	11.0 Max	11.0 Max	11.0 Max
Figure		A, D	A, D	B, E	A, D	C	F

Packing information

Bulk packing

Series	Straight Lead Type Quantity(pcs/bag)	Cut Lead Type Quantity(pcs/bag)	Kink Type Quantity(pcs/bag)
CNR-05N	1000	1000	1000
CNR-07N	1000	1000	1000
CNR-10N	500	500	500
CNR-14N	500	500	500
CNR-18N	250	250	250
CNR-20N	250	250	250

Tape & Reel product packing

Series	A (mm)	Quantity (pcs/reel)
CNR-05N(201K~621K)-TRXX	43	2000
CNR-05N(681K~781K)-TRXX		1500
CNR-07N(201K~391K)-TRXX		2000
CNR-07N(431K~821K)-TRXX		1500
CNR-07N(201K~391K)-TRXX		2000
CNR-07N(431K~821K)-TRXX		1500
CNR-10N(201K~621K)-TRXX	56	1000
CNR-10N(681K~112K)-TRXX		800
CNR-14N(201K~391K)-TRXX		800
CNR-14N(431K~621K)-TRXX		700
CNR-14N(681K~112K)-TRXX		600

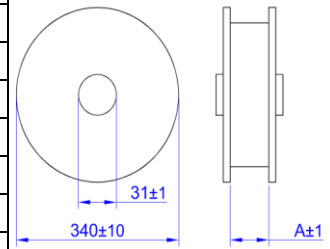

Flat Box product

Series	Quantity (pcs/box)
CNR-05N(201K~621K)-BTXX	1000
CNR-05N(681K~781K)-BTXX	800
CNR-07N(201K~621K)-BTXX	1000
CNR-07N(681K~781K)-BTXX	800
CNR-10N(201K~621K)-BTXX	1000
CNR-10N(681K~112K)-BTXX	800
CNR-14N(201K~621K)-BTXX	500
CNR-14N(681K~112K)-BTXX	400

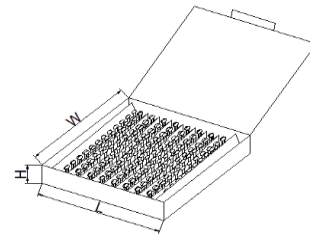

Series	L±5	W±5	N±5
CNR-05N~07N	340	245	45
CNR-10N~14N	340	245	50

Solder Recommendation

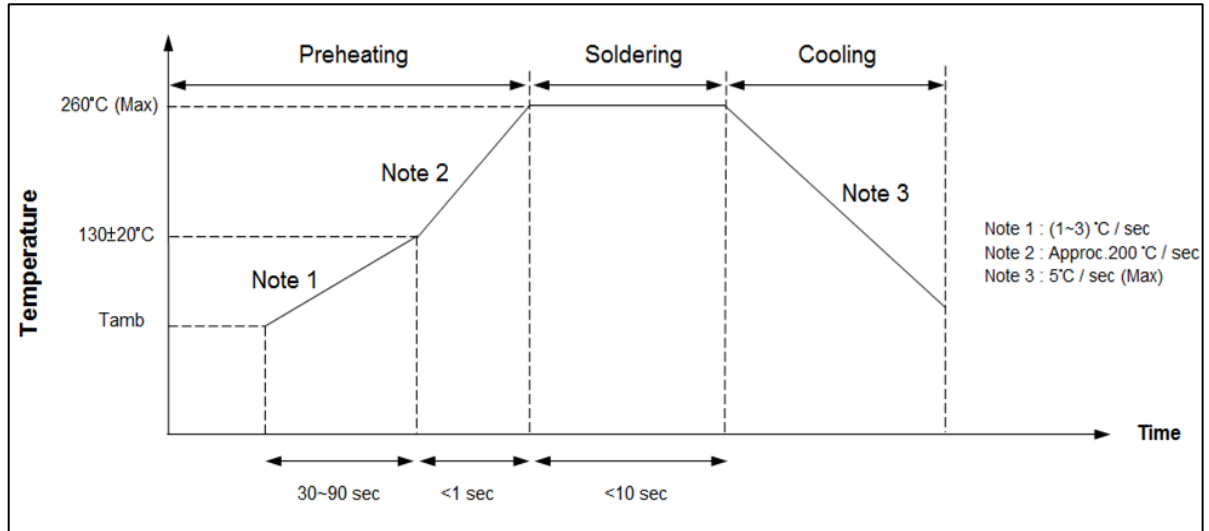

Recommendation Reworking Conditions with Soldering Iron

Item	Conditions
Temperature of soldering Iron-tip	360°C (Max)
Soldering Time	3 sec (Max)
Distance from Varistor	2mm (Min)

RoHS Compliant Declaration

We hereby declare that the components delivered to your company are compliant with RoHS Directive 2002/95/EC

Storage Conditions of Products

- (I) Storage Conditions:
- 1.Storage Temperature: -10°C ~+40°C
 - 2.Relative Humidity: ≤ 75% RH
 - 3.Keep away from corrosive atmosphere and sunlight
 - 4.Solvent Resistance: MIL-STD-202, Method 215F
 - 5.Moisture Sensitivity: Level 1, J-STD-020

(II) Period of Storage: 1 year



Explanation of Part Numbers

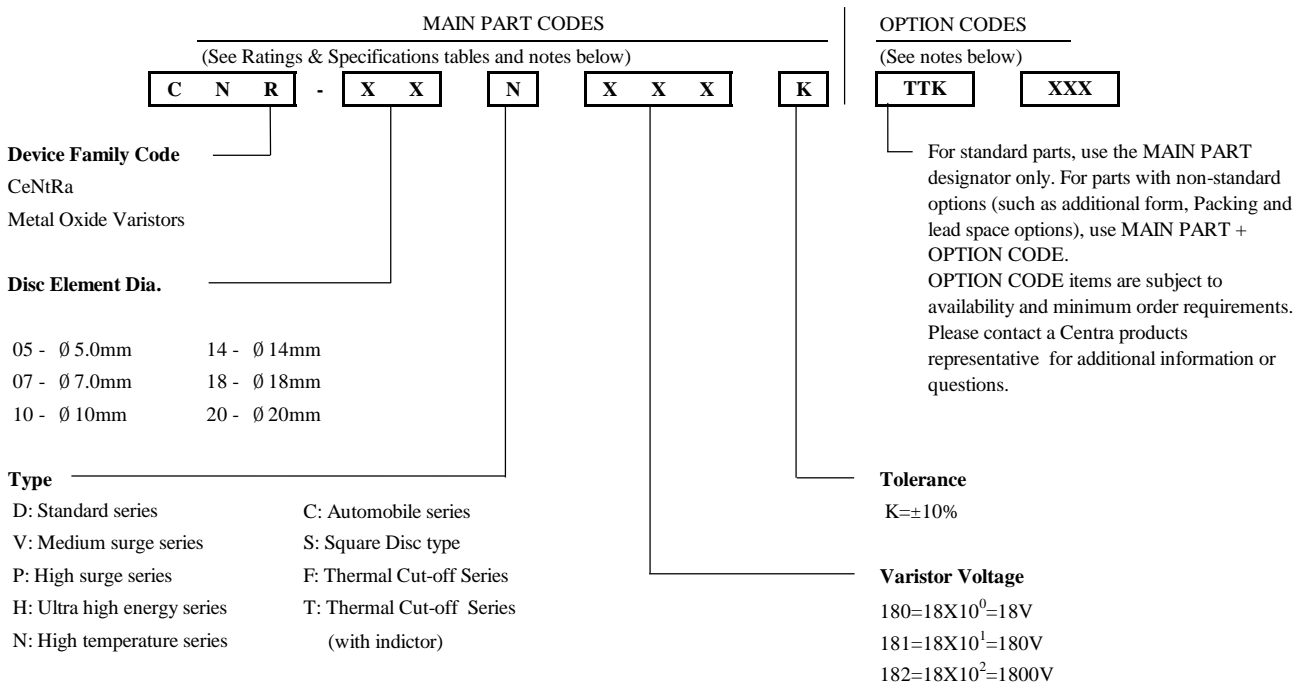

Ordering Notes:

MAIN PART CODES

Series + /Packaging/ Lead Style / Designators:

Ordering examples:

Straight Lead Bulk Pack (Standard)	Straight Lead (Short Cut) Bulk Pack	Straight Lead Tape & Reel Pack	Straight Lead Flat Box Pack
CNR-10N471K	CNR-10N471KTTSXXX	CNR-10N471KTRSX	CNR-10N471KBTSX
Outside Kink Lead Bulk Pack	Outside Kink Lead (Short Cut) Bulk Pack	Outside Kink Lead Tape & Reel Pack	Outside Kink Lead Flat Box Pack
CNR-10N471SOK	CNR-10N471KTTKXXX	CNR-10N471KTRKX	CNR-10N471KBTKX
Inside Kink Lead Bulk Pack	Inside Kink Lead (Short Cut) Bulk Pack	Inside Kink Lead Tape & Reel Pack	Inside Kink Lead Flat Box Pack
CNR-10N471KSIK	CNR-10N471KTTIXXX	CNR-10N471KTRIX	CNR-10N471KBTIX
In Line Kink Lead Bulk Pack	In Line Kink Lead (Short Cut) Bulk Pack	In Line Kink Lead Tape & Reel Pack	In Line Kink Lead Flat Box Pack
CNR-10N471KSHK	CNR-10N471KTTHXXX	CNR-10N471KTRHX	CNR-10N471KBTHX

Option Code

+ XXX

Short Cut Lead Length 10mm±1.0mm
CNR-10N471KTTS10

Tape & Reel Pack Feed Hole Pitch
CNR-10N471KTRSA
CNR-10N471KTRSB

A: P₀ → 12.7mm±0.2mm
B: P₀ → 15.0mm±0.2mm

CeNtRa N Series varistors are shipped standard in bulk pack with straight leads or Kink lead and lead spacing outlined in the Package Dimensions section of this data sheet. Contact your CeNtRa sales representative to discuss non-standard options.